

P-51D MUSTANG GIANT SCALE



WARRANTY.....

Top Flite Models guarantees this kit to be free of defects in both material and workmanship at the date of purchase. This warranty does not cover any component parts damaged by use or modification. In no case shall Top Flite's liability exceed the original cost of the purchased kit. Further, Top Flite reserves the right to change or modify this warranty without notice.

In that Top Flite has no control over the final assembly or material used for final assembly, no liability shall be assumed nor accepted for any damage resulting from the use by the user of the final user-assembled product. By the act of using the user-assembled product the user accepts all resulting liability.

If the buyer is not prepared to accept the liability associated with the use of this product, the buyer is advised to immediately return this kit in new and unused condition to the place of purchase.



**Top Flite Models
P.O. Box 788
Urbana, IL 61803**

Technical Assistance - Call (217)398-8970

READ THROUGH THIS INSTRUCTION BOOK FIRST. IT CONTAINS IMPORTANT INSTRUCTIONS AND WARNINGS CONCERNING THE ASSEMBLY AND USE OF THIS MODEL.

TABLE OF CONTENTS AND BUILDING SEQUENCE

| | |
|-----------------------------------|-------|
| INTRODUCTION..... | 3 |
| PRECAUTIONS | 3 |
| DECISIONS YOU MUST MAKE..... | 3 |
| ENGINE SELECTION | 3 |
| RADIO SYSTEM REQUIREMENTS | 3 |
| LANDING GEAR | 4 |
| SCALE COCKPIT INTERIOR..... | 4 |
| COMPETITION-MINDED MODELERS..... | 4 |
| DOCUMENTATION | 4 |
| OTHER ITEMS REQUIRED | 4 |
| BUILDING SUPPLIES | 4 |
| TOOLS..... | 5 |
| OPTIONAL TOOLS & SUPPLIES | 5 |
| IMPORTANT BUILDING NOTES..... | 5 |
| DIE-CUT PATTERNS..... | 6 & 7 |
| COMMON ABBREVIATIONS | 8 |
| TYPES OF WOOD | 8 |
| METRIC CONVERSIONS..... | 8 |
| GET READY TO BUILD | 8 |
| BUILD THE TAIL SURFACES | 9 |
| BUILD THE STABILIZER..... | 9 |
| BUILD THE FIN | 11 |
| BUILD THE RUDDER | 12 |
| BUILD THE WING | 13 |
| BUILD THE MAIN STRUCTURE..... | 13 |
| JOIN THE WING PANELS..... | 18 |
| SHEET THE BOTTOM OF THE WING..... | 20 |
| SHEET THE TOP OF THE WING | 22 |
| BUILD THE AILERONS..... | 23 |
| INSTALL THE WING TIPS | 24 |
| BUILD THE FLAPS | 24 |
| BUILD THE FUSELAGE..... | 26 |
| BUILD THE FUSE SIDES | 26 |
| INSTALL THE RADIATOR..... | 30 |
| INSTALL THE FIREWALL..... | 31 |
| MOUNT THE WING TO THE FUSELAGE .. | 32 |
| ATTACH THE STAB AND FIN..... | 33 |
| BUILD THE ELEVATORS | 35 |

| | |
|--------------------------------------|------------|
| ENGINE INSTALLATION | 37 |
| FUSELAGE COMPLETION..... | 37 |
| INSTALL THE DORSAL FIN | 40 |
| MAKE THE TOP COWL | 40 |
| ASSEMBLE THE COWL | 41 |
| BUILD THE WING FILLETS..... | 43 |
| INSTALL THE FORWARD WING FAIRING .. | 44 |
| FIT THE SCOOP..... | 44 |
| HINGING THE CONTROL SURFACES..... | 45 |
| INSTALL THE AILERON & FLAP SERVOS .. | 46 |
| INSTALL THE RUDDER PUSHROD | 48 |
| INSTALL THE THROTTLE PUSHROD | 48 |
| RETRACT INSTALLATION | 49 |
| FINISHING | 49 |
| SURFACE PREPARATION..... | 49 |
| BALANCE THE MODEL Laterally..... | 50 |
| COVERING | 50 |
| APPLY TRIM | 51 |
| EXHAUST STACKS..... | 51 |
| PAINTING | 52 |
| APPLY DECALS | 52 |
| FINAL HOOKUPS AND CHECKS | 52 |
| INSTALL THE HINGES | 52 |
| INSTALL THE HARDWARE | 52 |
| ATTACH THE CANOPY | 53 |
| SET THE CONTROL THROWS | 53 |
| BALANCE YOUR MODEL..... | 54 |
| PREFLIGHT | 54 |
| CHARGE THE BATTERIES | 54 |
| BALANCE THE PROPELLER | 54 |
| FIND A SAFE PLACE TO FLY | 55 |
| GROUND CHECK THE MODEL..... | 55 |
| RANGE CHECK YOUR RADIO..... | 55 |
| ENGINE SAFETY PRECAUTIONS..... | 55 |
| AMA SAFETY CODE..... | 55 |
| FLYING | back cover |
| FUEL MIXTURE ADJUSTMENTS .. | back cover |
| TAKE OFF | back cover |
| FLIGHT | back cover |
| LANDING | back cover |

PROTECT YOUR MODEL, YOURSELF & OTHERS FOLLOW THIS IMPORTANT SAFETY PRECAUTION

Your Giant P-51D is not a toy, but a sophisticated working model that functions very much like an actual airplane.

Because of its realistic performance and size, if you do not assemble and operate your P-51 correctly, you could possibly injure yourself or spectators and damage property.

To make your R/C modeling experience totally enjoyable, get assistance with assembly and your first flights from an experienced, knowledgeable modeler. You'll learn faster and avoid risking your model before you're truly ready to solo. Your local hobby shop has information about flying clubs in your area whose membership includes qualified instructors.

You can also contact the Academy of Model Aeronautics (AMA), which has more than 2,300 chartered clubs across the United States. We recommend you join the AMA which will insure you at AMA club sites and events. AMA membership is required at chartered club fields where qualified flight instructors are available.

Contact the AMA at the address or toll-free phone number below:

Academy of Model Aeronautics
5151 East Memorial Drive
Muncie, IN 47302-9252
Tele. (800) 435-9262
Fax (765) 741-0057

or via the internet at : <http://www.modelaircraft.org>

Your Top Flite Gold Edition Giant P-51D is intended for scale and general sport flying including **mild** aerobatics such as loops, stall turns, rolls, etc. Its structure is designed to withstand such stresses. If you intend to use your P-51D for more abusive types of flying, such as racing or aggressive aerobatics, it is your responsibility to reinforce areas of the model that will be subjected to the resulting unusually high stresses.

INTRODUCTION

Thank you for purchasing the **Top Flite Giant Scale Gold Edition P-51D Mustang**. Since this is a scale model with lots of detail, you'll find it takes a little longer to complete than the sport models you've built before. But since this is a Top Flite Gold Edition kit, it isn't more difficult to build than those sport models. The Top Flite Giant Mustang uses the same materials and standard construction techniques you've already become accustomed to. You won't have to learn anything new to end up with a first-class scale model! Most of the trim schemes you'll find of the full-size Mustangs should be easy to duplicate with Top Flite MonoKote film. The Top Flite Giant Mustang is an excellent Sportsman or Expert Scale subject. Its large size and accurate scale outline afford you the opportunity to go all-out with as many extra details as you like.

The Top Flite P-51D is an excellent sport scale model that is just as "at home" with sport flying as it is in competition. Because of its 84-1/2" wingspan, the Top Flite P-51D is eligible for IMAA events. The IMAA (International Miniature Aircraft Association) is an organization that promotes non-competitive flying of giant scale models.

IMAA
205 S. Hilldale Road
Salina, KS 67401

NOTE: We, as the kit manufacturer, provide you with a top quality kit and great instructions, but ultimately the quality and flyability of your finished model depends on how you build it; therefore, we cannot in any way guarantee the performance of your completed model, and no representations are expressed or implied as to the performance or safety of your completed model.

Please inspect all parts carefully before starting to build! If any parts are missing, broken or defective, or if you have any questions about building or flying this model, please call us at (217) 398-8970 and we'll be glad to help. If you are calling for replacement parts, please look up the part numbers and the kit identification number (stamped on the end of the carton) and have them ready when calling.

PRECAUTIONS

1. You must build the plane **according to the plan and instructions**. Do not alter or modify the model, as doing so may result in an unsafe or unflyable model. **In a few cases the plan and instructions may differ slightly from the photos. In those instances you should assume the plan and written instructions are correct.**
2. You **must** take time to **build straight, true and strong**.
3. You must use a proper R/C **radio** that is in first class condition, the correct sized **engine** and correct **components** (fuel tank, wheels, etc.) throughout your building process.
4. You must properly **install** all R/C and other components so that the model operates properly on the ground and in the air.
5. You must **test** the operation of the model before every flight to insure that all equipment is operating

and you must make certain that the model has remained structurally sound.

6. If you are not already an experienced R/C pilot, you must **fly** the model **only with the help** of a competent, experienced R/C pilot.

DECISIONS YOU MUST MAKE

ENGINE SELECTION

Recommended engine size:

30 - 45cc displacement **Glow Engine**

30 - 60cc displacement **Gasoline Engine**

We strongly recommend the use of a soft engine mount of some kind, to relieve the stresses on the airframe and radio system and to make your aircraft quieter. J-Tec, Soundmaster and others produce soft mounts for large engines.

Note: If you are using a gasoline engine, you will need to make sure that your fuel lines and tank are made specifically to handle gasoline.

RADIO SYSTEM REQUIREMENTS:

The Top Flite Giant P-51D requires a minimum of 10 servos. Due to the large scale of this aircraft, the Giant P-51D requires high torque servos with a minimum of 45 inch/ounces of torque to control the split elevator (2 required), rudder (1 required) and ailerons (2 required). Two 1/4- scale servos may be used in place of the three servos used for the elevator and rudder. If 1/4-scale servos are used you will need to make an elevator joiner (not included) and may need to route the pushrods differently.

On our prototypes we used Y-connectors to connect the elevator servos. We also used Y-connectors to connect the flap servos.

LANDING GEAR

The Top Flite Giant P-51 is designed for the Robart #622-5 retracts. Robart # will work great if you prefer to use fixed main landing gear.

SCALE COCKPIT INTERIOR

Your model won't be complete without the Top Flite Giant P-51D Cockpit Kit (TOPQ8406). It includes the floor, side panels, full instrument panel and seat. The Cockpit Kit can easily be installed after the fuselage is completed. The servos and pushrods are located so the cockpit can be installed without any modification.

COMPETITION-MINDED MODELERS

The Giant P-51D was enlarged from the .60 size Top Flite Gold Edition P-51D. The .60 size P-51D was finished with Top Flite Super MonoKote®. The MonoKote-covered prototype was good enough to finish 2nd in Expert at the very competitive 1992 **Blue Grass Scale Classic** in Kentucky. It scored quite well in static due to its excellent outline and posted the highest flight scores in the expert category.

If you plan to enter your Giant P-51D in scale competition (it's lots of fun and the runways are almost always paved), this kit qualifies for **Fun Scale** and the *Sportsman* and *Expert* classes in **Sport Scale**. Fun Scale and Sport Scale have the same flight requirements where you must perform ten maneuvers of which five are mandatory. If you have never competed in a scale contest, you could start out in Fun Scale. In Fun Scale, the only documentation you need for static judging is any proof that a full-size aircraft of this type, in the paint/markings scheme on your model, did exist. A single photo, kit box cover, even a painting is

sufficient proof! If you're interested, contact the AMA for a rule book which will tell you everything you need to know. Look in the back of the AMA magazine **Model Aviation** for a schedule of events.

The trim scheme of the P-51D on your kit box was inspired by the full scale "OLD BOY" with only slight modifications. The decal set included with the kit will allow you to quickly and easily duplicate the markings. If you prefer a different trim scheme, **Scale Model Research** offers many documentation packages as a guide.

DOCUMENTATION

Three view drawings and photo packs of many full size P-51s are available from:

Scale Model Research

3114 Yukon Ave, Costa Mesa, CA 92626
(714) 979-8058

OTHER ITEMS REQUIRED

These are additional items you will need to complete your P-51D that are not included with your kit. Order numbers are in parentheses (GPMQ4161). Our exclusive brand is listed where possible: **TOP** is the Top Flite brand, **GPM** is the Great Planes brand and **HCA** is the Hobbico brand.

- 6 to 7-channel radio with 10 servos (5 standard and 5 with a minimum of 45 inch/ounces of torque We recommend a 6-volt 1200mAh receiver battery
- (2) 24" Servo extensions for ailerons
- (3) "Y" Harnesses for elevator, rudder/tail wheel steering and flaps
- Main retracts (Robart # 622-5) (ROBQ1635)
- Tailwheel retract (Robart # 160LWC) (ROBQ2225)
- Air control kit
- (2) 5" Main wheels

- 1-3/4" Tail wheel
- 16-24 oz. Fuel tank
- 5" Spinner
- 36" Gas or glow fuel tubing depending on type of fuel used
- 1/2" R/C foam rubber padding (HCAQ1050)
- 1/4 to 1/5 Scale pilot figure
- (5) Heavy-duty control horns
- (26) Heavy-duty hinge points
- Pull - pull cable system for steerable tail wheel
- Easy Fueler™ Fuel Fill Valve for gas (GPMQ4161) or glow (GPMQ4160)
- Switch & Charge Jack Mounting Set (GPM1000)
- Fuelproof paint (Top Flite® LustreKote™ paint)
- Air tank
- (16) #6 x 1/2" sheet metal screws for mounting the retracts
- Engine mount (Isolation mount recommended)
- Propellers, see the engine instructions
- 4-5 rolls Top Flite Super MonoKote covering

BUILDING SUPPLIES

The following is a list of building supplies that are required. We recommend Great Planes Pro™ CA and Epoxy.

- 4 oz. Thin CA (GPMR6003)
- 4 oz. Medium CA+ (GPMR6009)
- 2 oz. Thick CA- (GPMR6015)
- CA Accelerator (GPMR6035)
- CA Debonder (GPMR6039)
- 6-Minute epoxy (GPMR6045)
- 30-Minute epoxy (GPMR6047)
- 4 oz. Pro wood glue (GPMR6161)
- Canopy glue
- Microballoons (TOPR1090)
- Milled fiberglass (GPMR6165)
- Lightweight hobby filler (Balsa Color, HCAR3401)
- Auto body filler (Bondo® or similar)
- Isopropyl alcohol
- 3M #75 or #77 spray adhesive

TOOLS

- Sealing iron (TOPR2100)
- Heat gun (TOPR2000)
- Hobby saw, hobby knife (HCAR0100), #11 Blades (HCAR0211)
- Razor plane (Master Airscrew®)
- Pliers (common and needle nose)
- Screw drivers (Phillips and flat tip)
- T-pins (HCAR5150)
- 60" Retractable Fabric Tape Measure (HCAR0478)
- Straightedge with scale (HCAR0475)
- Masking tape (TOPR8018)
- Sandpaper (coarse, medium, fine grit)
- Easy-Touch™ Bar Sander (or similar)
- Plan Protector (GPMR6167)
- Tack cloth (TOPR2185)
- 1/4-20 Tap (GPMR8105) and tap wrench (GPMR8120)
- 90P Building square
- Builders triangle set (HCAR0480)
- .050 Long handle ball driver (GPMR8000)
- Hand or electric drill
- Drill bits: 1/16", 5/64", 3/32", 7/64", 1/8", 9/64", 5/32", 3/16", 13/64", 1/4", 17/64", 5/16", 3/8"
- Epoxy mixing sticks (GPMR8055)

OPTIONAL SUPPLIES AND TOOLS

- CA Applicator tips (HCAR3780)
- Epoxy brushes (GPMR8060)
- Hot Sock™ (TOPR2175)
- Single-edge razor blades (HCAR0312)
- Curved-tip canopy scissors (HCAR0667)

EASY-TOUCH BAR SANDER

On our workbench, we have three 11" **Great Planes Easy-Touch Bar Sanders**, equipped with #80, #150 and #220-grit sandpaper. This setup is all that is required for almost any sanding task. We also keep some #320-grit wet-or-dry sandpaper handy for finish sanding before covering.



Great Planes **Easy-Touch Bar Sanders** are made from lightweight extruded aluminum and can be found at most hobby shops. They are available in five sizes :

| | |
|-------------------|----------------|
| 5-1/2" (GPMR6169) | 33" (GPMR6174) |
| 11" (GPMR6170) | 44" (GPMR6176) |
| 22" (GPMR6172) | |

The **Easy-Touch Adhesive-Backed Sandpaper** comes in 2" x 12' rolls:

| |
|---------------------|
| 80-grit (GPMR6180) |
| 150-grit (GPMR6183) |
| 220-grit (GPMR6185) |

Assortment of 5-1/2" long strips (GPMR6189)

IMPORTANT BUILDING NOTES

There are two types of screws used in this kit. **Sheet metal screws** are designated by a number and a length.

For example #6 x 3/4"



Machine screws are designated by a number, threads per inch and a length.

For example 4-40 x 3/4"

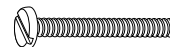

To prevent some of the die-cut parts from falling out of the die sheets, the parts may not be completely cut out. Do not force the parts from the sheets. Use a sharp hobby knife to carefully finish cutting the parts out.

When you see the term "**test fit**" in the instructions, it means you should first position the part on the assembly **without using any glue** and then slightly modify or sand the part as necessary for the best fit.

Whenever the instructions tell you to **glue** pieces together, CA or epoxy may be used. When a **specific** type of glue is required, the instructions will state the type of glue that is **highly recommended**. When 30-minute epoxy is **specified**, it is highly recommended that you use only 30-minute (or slower) epoxy because you will need either the working time and/or the additional strength.

To avoid irreversible mistakes, read each step **completely through to the end** before you begin.

Photos and **sketches** are placed ahead of the step they refer to. Frequently you can study photos in following steps to get another view of the same parts.

DIE-CUT PATTERNS

P51GF35 SPINNER RING 1 PER KIT
P51GF14 AILERON SERVO BAY COVER 2 PER KIT
P51GF14 FLAP SERVO BAY COVER 2 PER KIT
P51GF14 RETRACT BAY COVER

1/16" X 4-3/4" X 9-3/4" BIRCH PLY
 1/16" X 4-3/8" X 11-3/4" BIRCH PLY

P51GF08 2 PER KIT
P51GF08 PLYWOOD FUSE DOUBLER
P51GF08 VALVE MOUNTS 1/8" X 4-1/8" X 31-3/4" PLY

P51GF32 1 PER KIT
P51GF32 1 PER KIT

1/8" X 4-3/4" X 14-3/4" BIRCH PLY

P51GF07 2 PER KIT
P51GF07 STEERING SERVO TRAY
P51GF07 FORWARD CRUTCH
 1/8" X 3-3/4" X 31-3/4" PLY

P51GF05 1 PER KIT
P51GF05 1 PER KIT

1/8" X 6-1/2" X 19" BIRCH PLY

P51GF33 1 PER KIT
P51GF33 CENTER TRAY
P51GF33 TANK FLOOR 1 PER KIT

1/8" X 5-1/8" X 31-3/4" PLY

P51GF13 1 PER KIT
P51GF13 1 PER KIT

1/8" X 3-1/4" X 23-3/4" PLY

P51GW08 2 PER KIT
P51GW08 LANDING GEAR DOORS
P51GW08 1 PER KIT

1/8" X 5-1/8" X 31-3/4" PLY

P51GW06 2 PER KIT
P51GW06 DIHEDRAL BRACE
P51GW06 1 PER KIT

1/8" X 3-1/2" X 24-3/4" BIRCH PLY

P51GF10 1 PER KIT
P51GF10 FRONT SPACER PLATE
P51GF10 1 PER KIT

1/8" X 3-3/4" X 31-3/4" PLY

P51GF16 1 PER KIT
P51GW16 WING FILLET BASE
P51GF16 1 PER KIT

1/32" X 4-1/8" X 29-3/4" BIRCH PLY

P51GF09 1 PER KIT
P51GF09 AFT CROSS BRACE 1 PER KIT
P51GF09 1 PER KIT

1/8" X 3-3/4" X 31-3/4" PLY

P51GF12 1 PER KIT
P51GF12 1 PER KIT
P51GF12 1 PER KIT
P51GF12 1 PER KIT

1/8" X 5-1/8" X 31-3/4" PLY

DIE-CUT PATTERNS

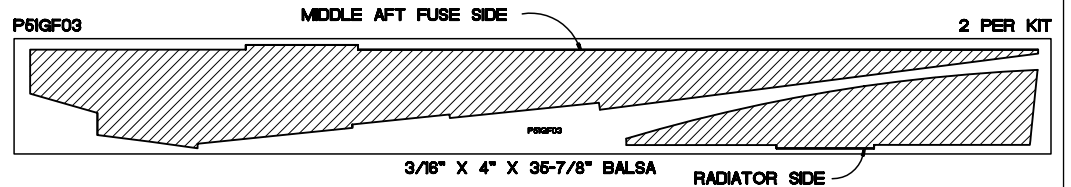
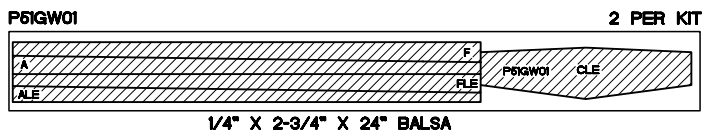
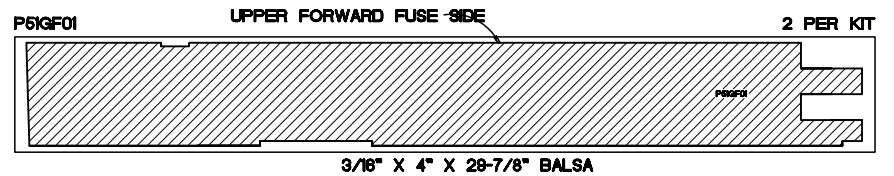
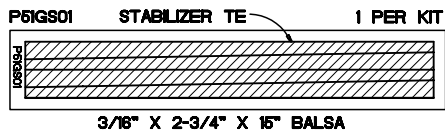
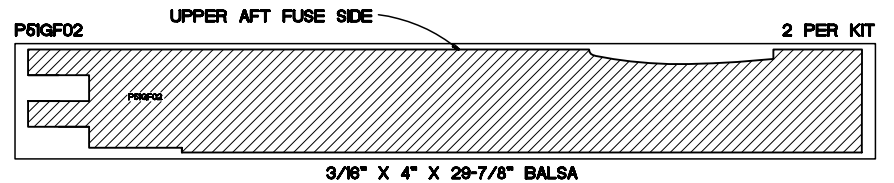
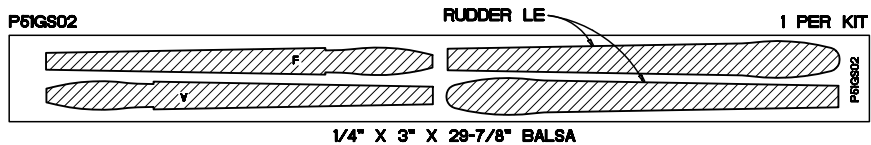
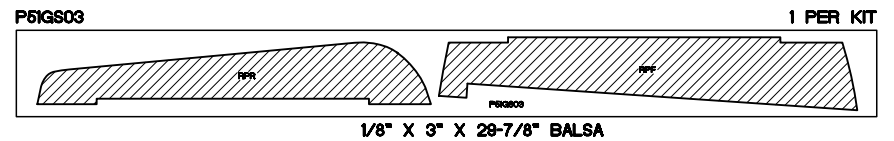
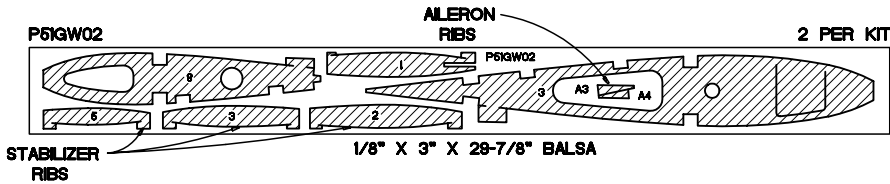
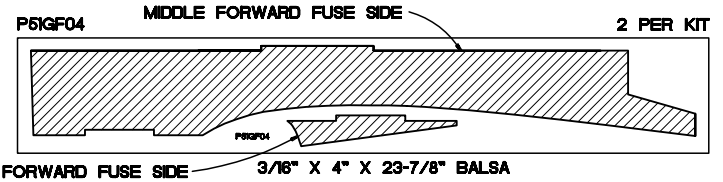
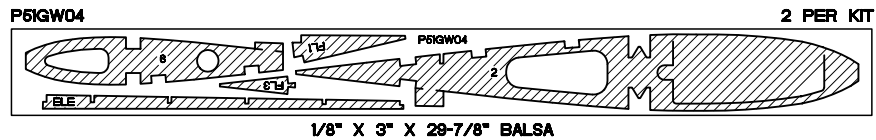
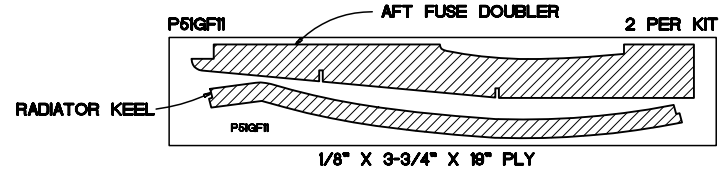
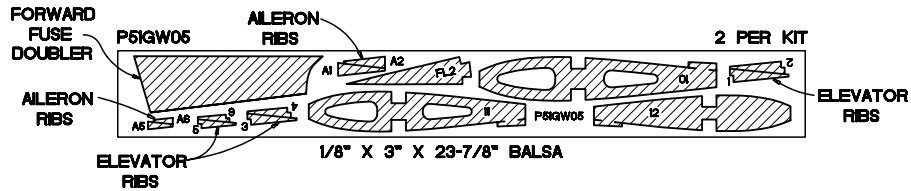
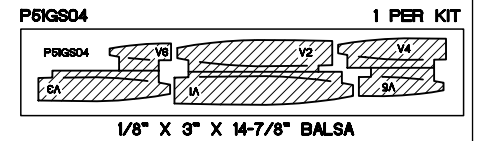
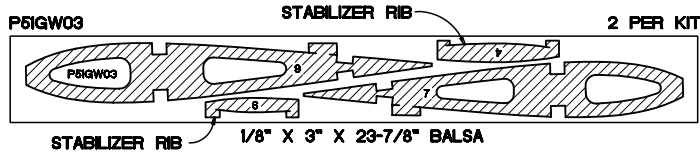
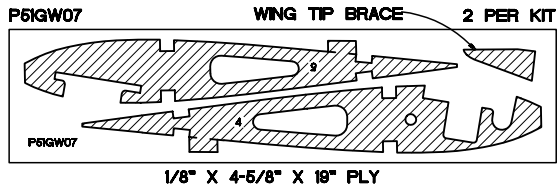

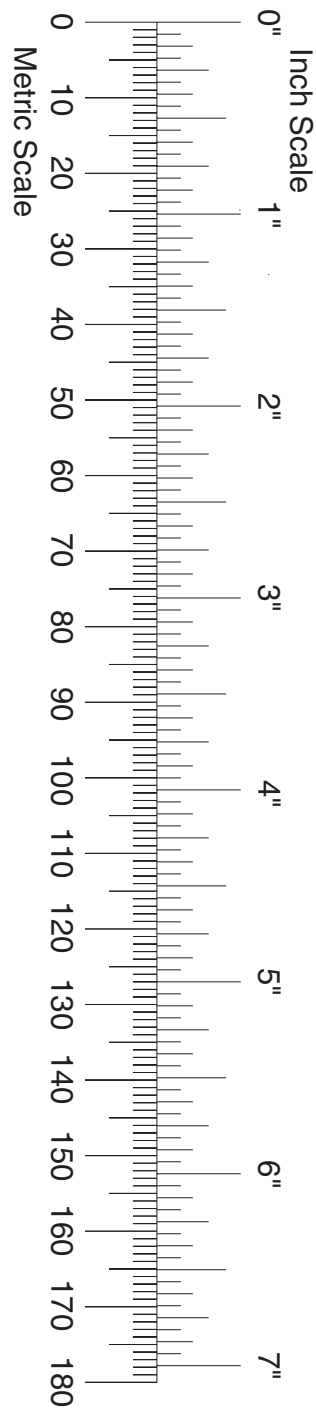

COMMON ABBREVIATIONS

| | |
|-------------------|--------------------|
| Deg = degrees | Elev = elevator |
| Fuse = fuselage | " = inches |
| LE = leading edge | Ply = plywood |
| Stab = stabilizer | TE = trailing edge |

TYPES OF WOOD

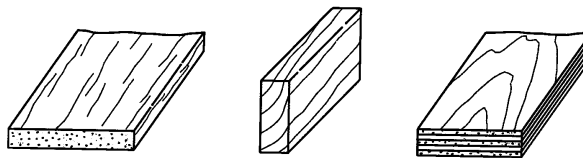

BALSA

BASSWOOD

PLYWOOD

METRIC CONVERSION

1" = 25.4mm (conversion factor)

| | |
|---------------|---------------|
| 1/64" = .4mm | 1" = 25.4mm |
| 1/32" = .8mm | 2" = 50.8mm |
| 1/16" = 1.6mm | 3" = 76.2mm |
| 3/32" = 2.4mm | 6" = 152.4mm |
| 1/8" = 3.2mm | 12" = 304.8mm |
| 5/32" = 4mm | 15" = 381mm |
| 3/16" = 4.8mm | 18" = 457.2mm |
| 1/4" = 6.4mm | 21" = 533.4mm |
| 3/8" = 9.5mm | 24" = 609.6mm |
| 1/2" = 12.7mm | 30" = 762mm |
| 5/8" = 15.9mm | 36" = 914.4mm |
| 3/4" = 19mm | |

GET READY TO BUILD

1. Unroll the plan sheets. Reroll the plan sheets inside out to make them lie flat. Wax paper or Great Planes **Plan Protector** placed over the plan will prevent glue from sticking to the plan.

2. Remove all parts from the box. As you do, determine the name of each part by comparing it with the plan and the **parts list** included with this kit. Using a pencil or ballpoint pen, lightly write the part **name** or **size** on each piece to avoid confusion later. Use the die-cut patterns shown on pages 6 and 7 to identify the die-cut parts and mark them **before** removing them from the sheet. **Save all scraps.** If any of the die-cut parts are difficult to remove, do not force them! Instead, cut around the parts. Use your Easy-Touch Bar Sander or sanding block to **lightly** sand the edges to remove any die-cutting irregularities.

3. As you identify and mark the parts, separate them into groups, such as **fuse** (fuselage), **wing**, **fin**, **stab** (stabilizer) and **hardware**. Zipper-top food storage bags are handy to store parts in as you sort, identify and separate them into subassemblies.

BUILD THE TAIL SURFACES

BUILD THE STABILIZER

- ❑ 1. Lay the plan of the stab on a flat work surface and cover it with wax paper or Plan Protector.

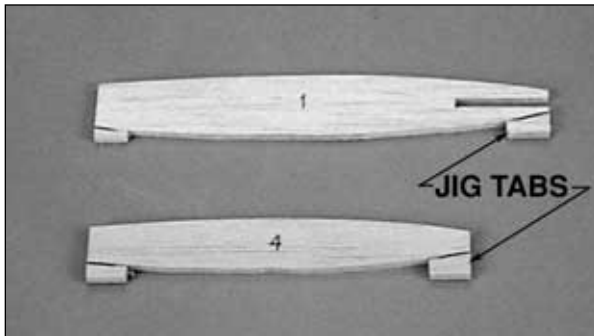

- ❑ 2. Locate and lightly sand any imperfections on the die-cut 1/8" balsa **stab ribs S-1** through **S-6**. You may need to finish cutting the notch in the forward portion of S-1 for the die-cut 1/8" birch ply **stab joiner (SJ)**. Mark the extensions of the bottom edge of the ribs across the fore and aft tabs. These will help centering the LE and TE.

- ❑ 3. Glue together two die-cut 3/16" balsa **stab TE's** to make two pairs of 3/8" thick stab TE's. Since some crushing may occur during die-cutting wood of this thickness, the TE's are supplied slightly long and can be trimmed.

- ❑ 4. The **stab** and **fin LE's** are made from 3/8" x 3/8" x 30" balsa sticks. Cut two pieces about 1/4" longer than the length shown on the stab plan.

- ❑ 5. Starting with the right half of the stab, pin ribs S-2 and S-6 perpendicular to the building board over their locations on the plan.

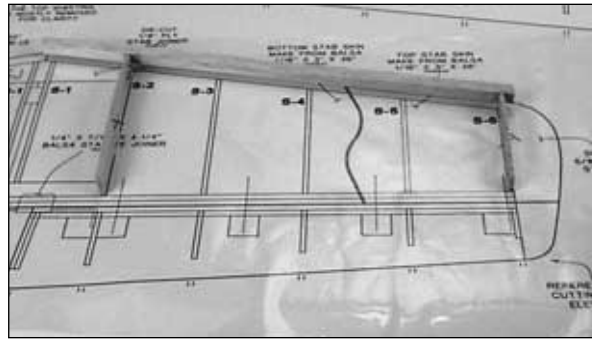

- ❑ 6. Use a sanding bar to sand an angle on the **LE of the ribs** so that the 3/8" x 3/8" LE fits flush on the LE of the ribs. Glue the LE, centered vertically, onto the front edge of ribs S-2 and S-6.

- ❑ 7. Glue the TE centered vertically on the aft edge of ribs S-2 and S-6.

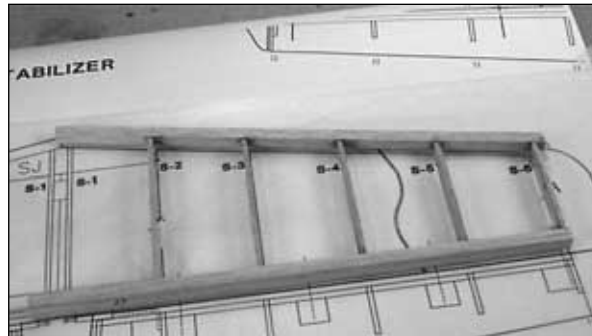

- ❑ 8. Glue ribs **S-3, S-4** and **S-5** in their places. Check that the jig tabs are contacting the building surface.

- ❑ 9. Trim the **LE** and **TE** so they end exactly over the stab **centerline**.

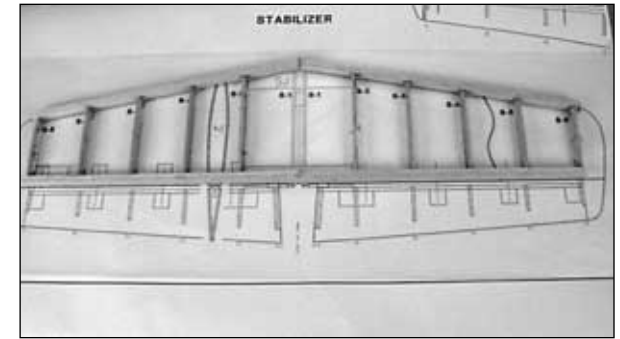

- ❑ 10. Repeat steps 5 through 8 to build the left half of the stab. The left half of the stab is built next to the right half with the two halves butt glued together.

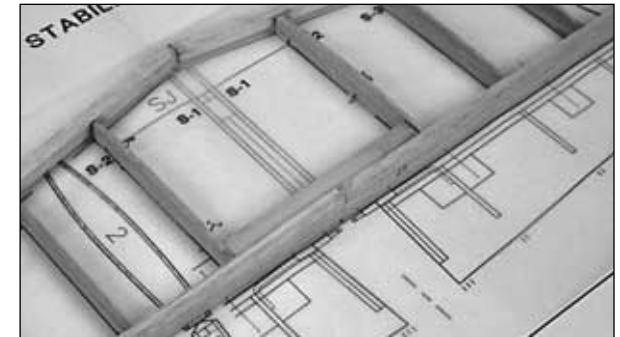

- ❑ 11. Trim the 3/8" x 17/32" x 5-3/8" basswood **TE joiner**, if necessary, to fit between the S-2 ribs. Use 6-minute epoxy to glue it centered vertically on the TE's and the ribs.



- ❑ 12. Check the fit of the die-cut 1/8" plywood **stab joiner (ST)** between the S-2 ribs and trim if necessary. Place the stab joiner into the slots in

the die-cut 1/8" balsa **S-1** ribs and insert the assembly into position to check the fit. Use 6-minute epoxy to glue the assembly into position, making sure all parts are properly aligned and the S-1 jig tabs contact the work surface.

13. Using medium CA, reinforce any glue joints that do not look strong.

14. Carefully remove the stab from the building board without damaging the jig tabs.



15. Use a razor plane and a sanding bar to blend the LE and TE to the top of the ribs.



HOW TO MAKE THE SKINS

A. Whenever possible, pre-join the balsa sheets to make a "skin" before attaching them to the structure.

B. Many modelers like to sort the wood to put the best wood with the most even grain structure on the top of the wing and stab.

C. Make your skin larger than needed to allow for misalignment. On a large surface like the wing, 3/8" extra is suggested.

D. To make skins the following steps are suggested:

1. True up the edges of the sheets with a metal straightedge and a sharp knife or a long bar sander.

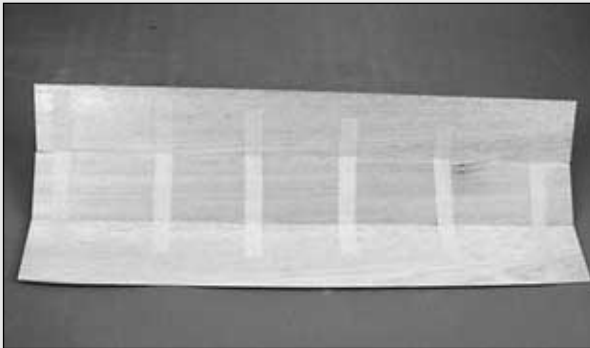

2. Test fit the sheets together to make sure they match well. Tightly tape the sheets together with masking tape placed every 4" along the seam. The sheets may not lay flat because they are tightly taped together.

3. Place wax paper on your workbench. Flip the sheets over and apply a bead of aliphatic resin (*wood workers glue* such as Great Planes Pro™) between the seams. Immediately proceed to the next step.

4. Use a credit card or a piece of thin plywood to simultaneously press the sheets flat as you squeegee the excess glue from the seam. Wipe the glue off your squeegee with a paper towel. Immediately proceed to the next step.

5. Press the joining edges of the sheets down with your fingers so they are flat and even. Place weights on top of the sheets to hold them flat until the glue dries.

6. After sheeting the structure, save any excess sheeting for possible use in later steps.

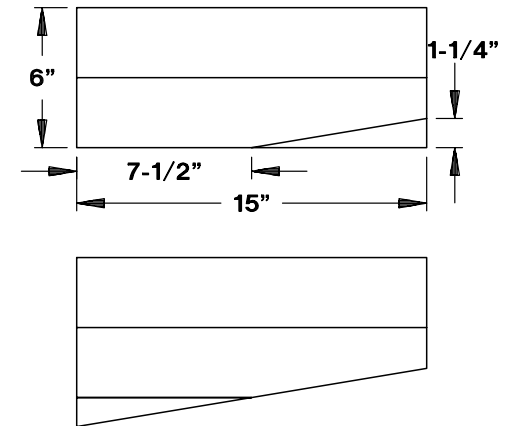

16. Make four stab skins from four 3/32" x 3" x 30" balsa sheets. Cut each sheet in half and edge glue two sheets together to make four skins 6" x 15". Trim the corner from the skin and glue the corner to the opposite end of the skin. See the sketch for the proper layout of the sheets.

17. Pin the stab back down on the building surface. Test fit the skins on the top of the stab. You will need to trim the skins at the root end, making sure the skins butt against each other with no gap at the root end.

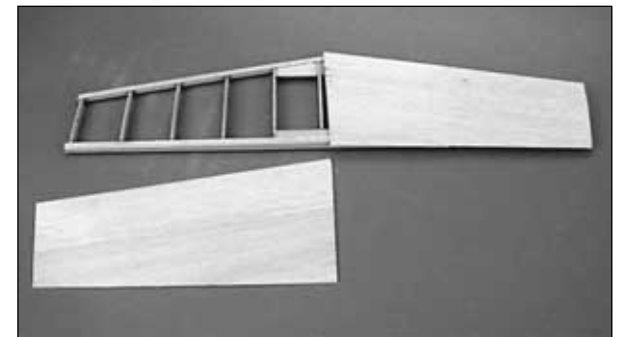

18. Apply an even bead of medium or thick CA to the right top edges of the stab. Place the right stab skin in position and press it firmly down until the glue has set. Repeat the process to install the left stab skin.

❑ 19. Remove the stab from the building surface. Trim off the jig tabs with a sharp knife. Trim and blend the **LE** and **TE** to the top of the ribs as you did before in step 15. Check all glue joints, adding glue as necessary.

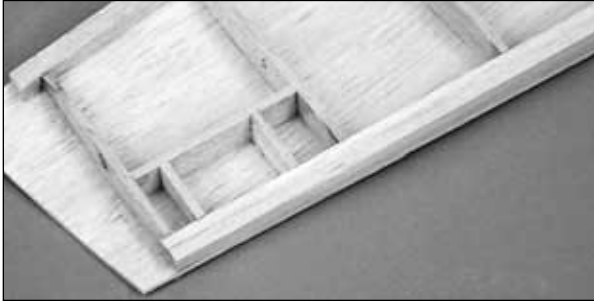

❑ 20. If you want to modify the stab for the scale balance tabs, now is the time to add the appropriate structure. Refer to the plan for the locations and sizes of the balance tabs (parts not included).

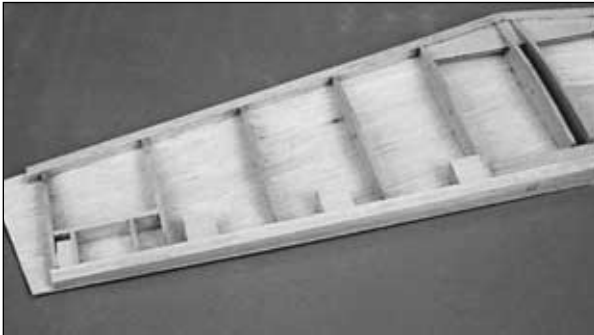

❑ 21. From the 3/4" x 3/4" x 30" balsa stick, cut 3/4" long **hinge point backups**. Glue the backups in position as shown on the plan. Sand the backups flush with the top of the stab ribs.

❑ 22. It is important to get a good glue bond between the stab structure and the bottom stab skins. Apply a heavy bead of medium or thick CA to all of the bottom edges of the right side of the stab structure. Place a skin on the structure and hold it in place with your hands until the glue sets. Repeat this procedure for the left stab skin. Be careful not to bend or twist the stab during this step.

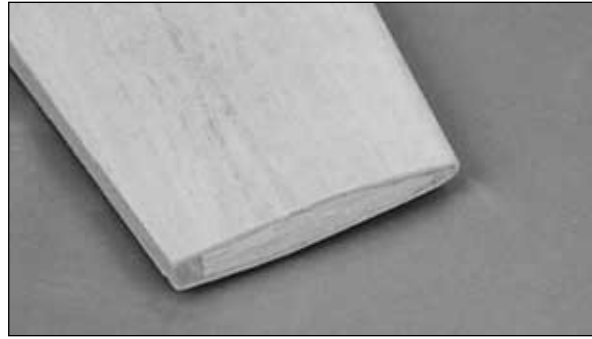

❑ 23. Sand the ends of the stab skins, LE and TE flush with the sides of the S-6 ribs. Round the LE of the stab to match the stab cross section shown on the plan.

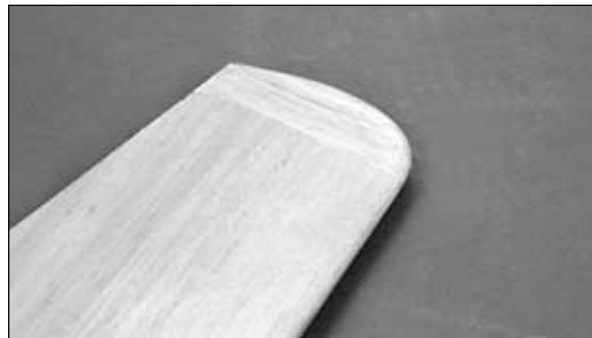
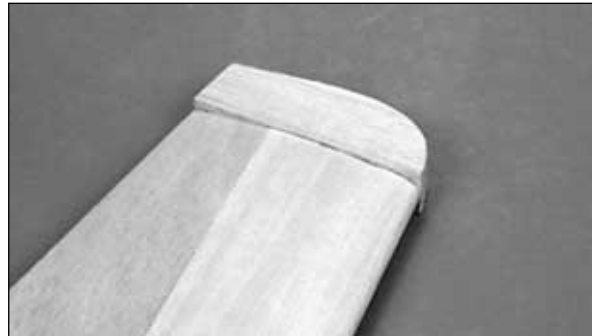

❑ 24. Glue the shaped 3/4" balsa **stab tips** onto both ends of the stab. Use a razor plane and sanding bar to shape the stab tips to match the contour of the stab.

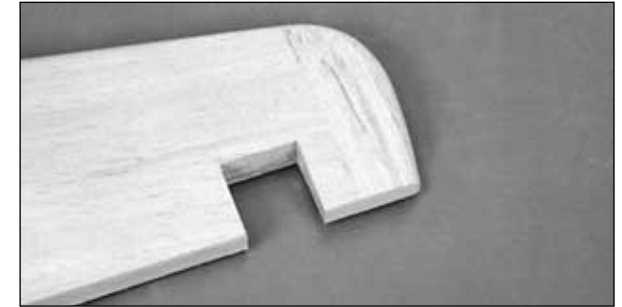

❑ 25. If you are building the stab with notches for balance tabs, trim the openings at this time.

BUILD THE FIN

❑ 1. From a 3/8" x 3/8" x 30" balsa stick make the fin LE.

❑ 2. Glue the die-cut 1/4" balsa **fin forward TE (F)** and **aft TE (A)** together. Lightly sand the edges of the TE's to blend them together.

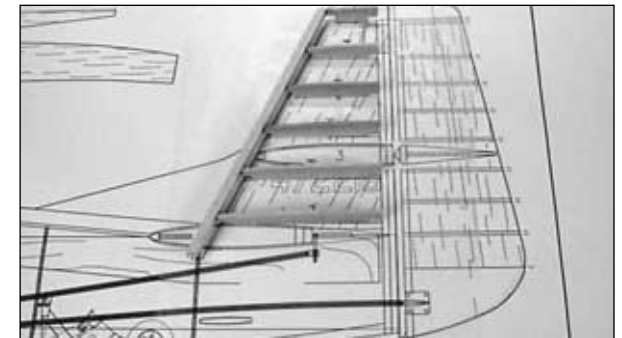

❑ 3. Locate the die-cut 1/8" balsa **fin ribs V-1** through **V-6**. Pin the ribs to your building surface over their proper locations. Center the LE on the front of the ribs and glue in place. **Note:** The fin LE protrudes through the stab and into former F-11.

❑ 4. Center the fin TE on the aft edge of the ribs and glue in place.

❑ 5. Apply medium CA to any joints that do not appear to be well glued.

- 6. Sand the LE to match the ribs on the upward facing side (left side). Sand the ends of the TE flush with the ribs.

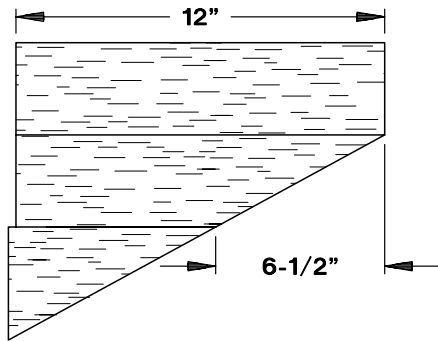

- 7. Make a **fin skin** for each side of the fin using two 3/32" x 3" x 30" balsa sheets. Cut each sheet into two 12" pieces. Edge glue the two pieces together and trim the corner of one piece as shown in the sketch.

- 8. With the structure flat on the building surface, apply medium CA to the top of the ribs, the LE up to rib V-1 and the TE up to the notch just after rib V-1. Place the fin skin on the structure with the bottom edge overhanging V-1 by at least 1/2" and hold in place until the glue sets.

Important: Make sure to remove the pins holding the ribs to the building surface before gluing the skin on.

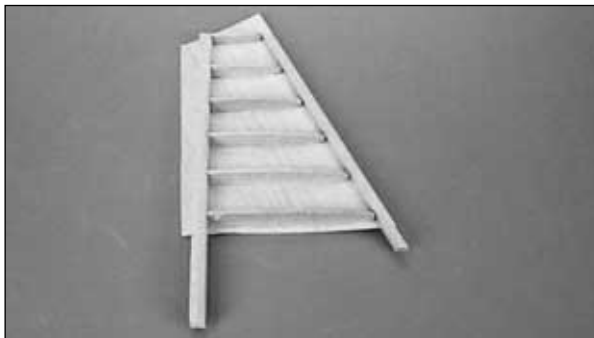

- 9. Trim off the jig tabs and blend the LE and TE to the ribs on the right side of the fin.

- 10. If you want to modify the fin for the scale balance tab, now is the time to add the appropriate structure. Refer to the plan for the location and size of the balance tab (parts not included).



- 11. From the 3/4" x 3/4" x 30" balsa stick cut 3/4" long **hinge point backups**. Glue the backups in position as shown on the plan and sand them flush with the top of the stab ribs.

- 12. Glue the right fin skin in position with the bottom edge overhanging V-1 by at least 1/2" .



- 13. Trim the skins flush with the LE, TE and top of the fin. Shape the LE to match the cross-section on the fin plan.

- 14. Glue the shaped 7/8" balsa fin tip to the top of the fin. Use a razor plane and sanding bar to do the initial shaping. The final shaping will be done after the rudder is taped to the fin.

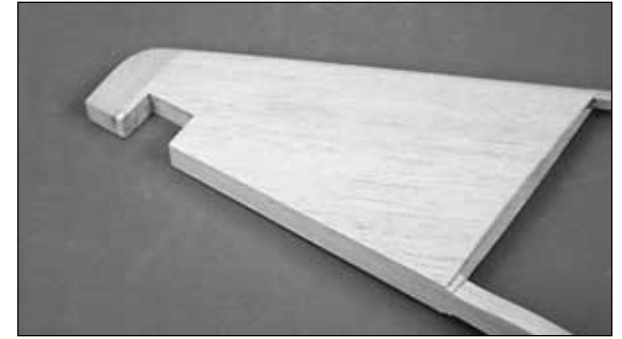

- 15. If you are building the fin with an opening for the balance tab, trim the opening at this time.

BUILD THE RUDDER

- 1. Glue the two die-cut 1/4" balsa **rudder LE's** together. Even up the edges with a sanding bar, but save any tapering for later.



- 2. Glue the die-cut 1/8" balsa **forward (RPF)** and **aft (RPR)** rudder plates together.

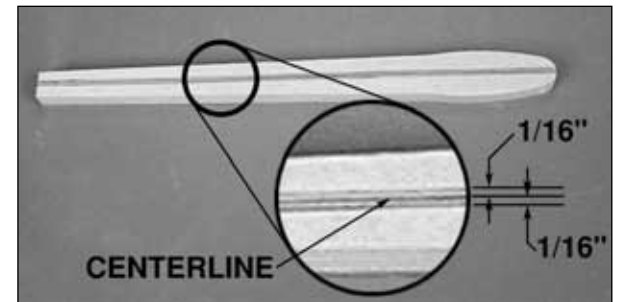

- 3. Draw a centerline on the aft surface of the rudder LE. Draw two parallel lines 1/16" on both sides of the centerline.

- ❑ 4. Align the rudder plate over the plan and mark the “rib” locations on both sides of the rudder plate. (See the photo in step 5).

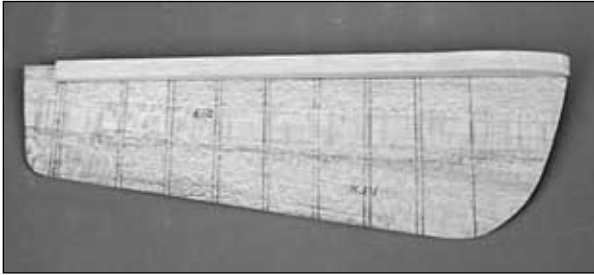

- ❑ 5. Glue the rudder plate, **centered**, on the rudder LE. Make sure the rudder plate is **perpendicular** to the rudder LE.

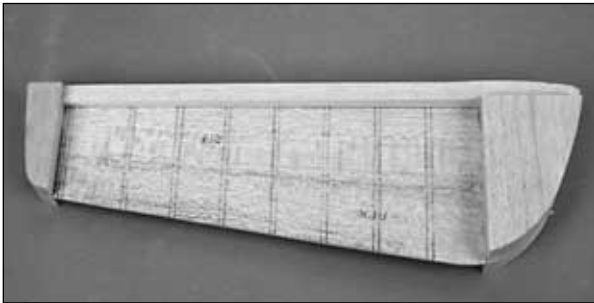

- ❑ 6. Glue the two shaped 1/2" balsa **rudder tips** and the two shaped 3/4" balsa **rudder bases** to both sides of the rudder plate.

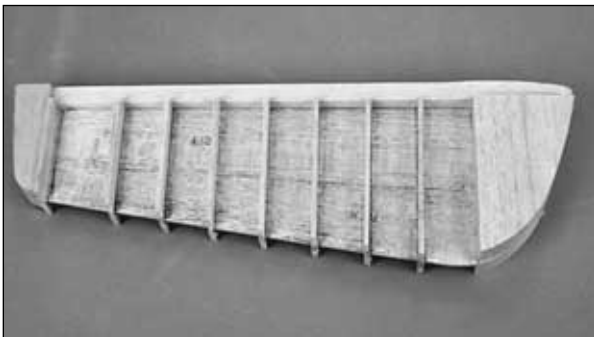

- ❑ 7. Cut “**ribs**” from the 1/8" x 5/8" x 30" balsa sticks. Glue the ribs to the rudder at the previously marked rib locations.

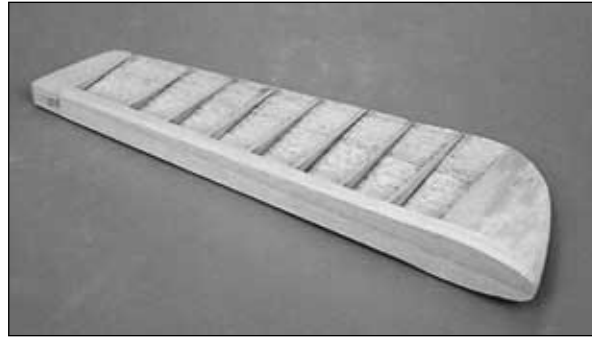

- ❑ 8. Refer to the photos and the cross section on the plan to obtain the shape of the rudder. Use a razor plane and sanding bar to “rough in” the shape of the rudder. Final shaping will be done after the rudder is attached to the fuse. Tape the rudder to the fin and shape the rudder and fin tips.

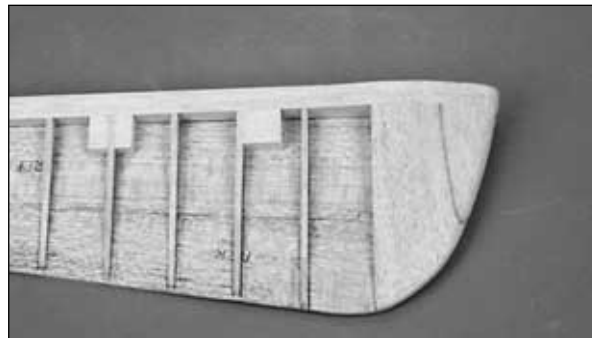

- ❑ 9. From the 3/4" x 3/4" x 30" balsa stick, cut 3/4" long hinge point backups. Glue the backups in position as shown on the plan and sand them flush with the ribs.

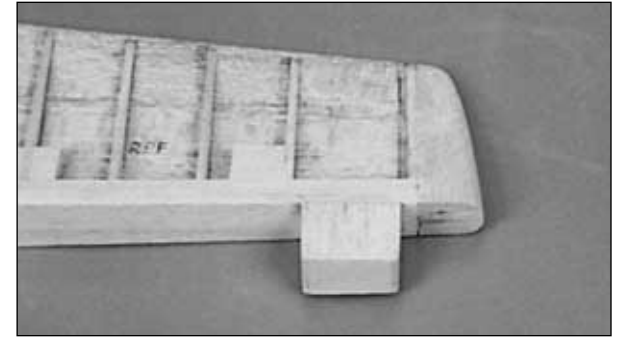

- ❑ 10. If you want to modify the rudder for the scale balance tab, now is the time to add the appropriate structure. We made our balance tab from leftover 3/32" balsa sheeting and leftover 1/8" balsa from the die sheets.

BUILD THE WING

NOTE: The wing panels are built “**upside-down**” on the plan. The jig tabs are attached to what is, in the end, the **top** of the wing.

IMPORTANT: Since it is standard to show the top of the wing on the plan and the wing panels are built upside-down, the **left** wing panel is built over the **right** wing top view and vice-versa. This does not present any problems. Just be sure to build a left and right wing panel.

BUILD THE MAIN STRUCTURE

- ❑ ❶ 1. Place the wing plan on your building surface and cover it with wax paper or Plan Protector.

- ❑ ❷ 2. Hold the 3/8" x 1/2" x 42" basswood spars over the wing plan. Cut the spars about 1/2" longer than required.

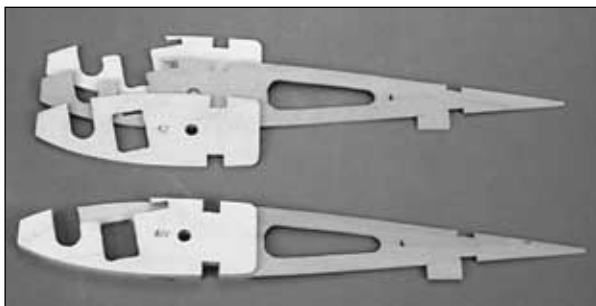
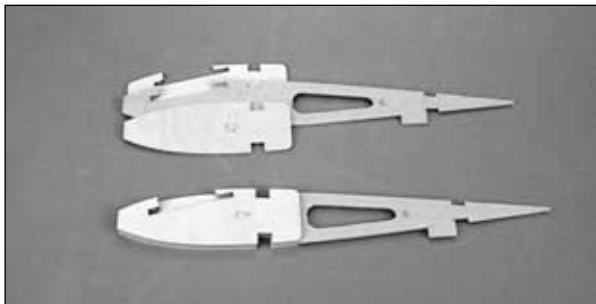

❑ 3. Use 30-minute epoxy to glue the die-cut 1/8" plywood wing ribs **W-5** between the lazer-cut 1/8" birch ply rib doublers **W-5W** and **W-5Z**. Use 30-minute epoxy to glue the die-cut 1/8" plywood wing ribs **W-4** between the lazer-cut 1/8" birch ply rib doublers **W-4W** and **W-4Z**. Take extra care to not get epoxy in the slots for the main spars and the retract rails.

IMPORTANT: Be sure to make a left and right rib assembly.



❑ 4. Glue a die-cut 1/4" balsa **aft aileron TE (A)** centered on a die-cut 1/4" balsa **forward**

aileron TE (F). Use a sanding bar to taper the two pieces slightly as shown in the wing cross-section drawing on the plan. These pieces are die-cut slightly long to allow you to trim off any imperfections.

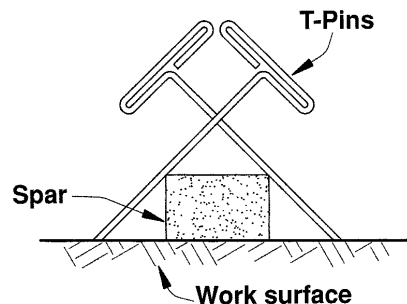

❑ 5. Pin a 3/8" x 1/2" x 42" basswood **main spar** to the building surface using the cross-pinning technique shown in the sketch. Allow the main spar to overhang the plan at the root end.

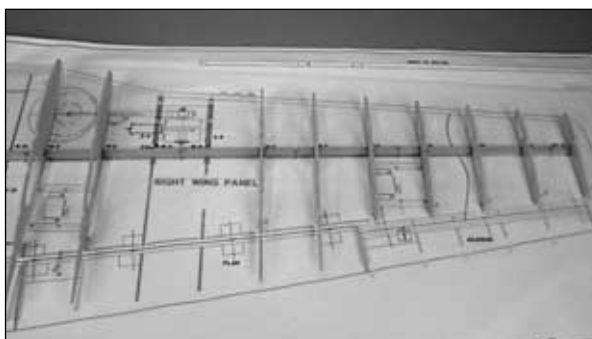

❑ 6. Glue the die-cut 1/8" balsa **ribs W-2, W-3** and **W-6** through **W-12** to the main spar. These should be perpendicular to the building surface and aligned over their appropriate locations. Pin the jig tabs located at the aft end of the ribs to the building surface.

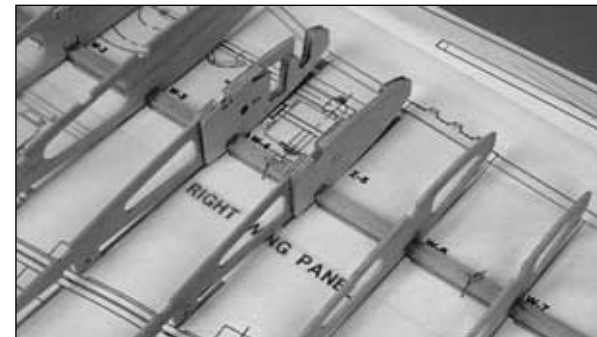

❑ 7. Use 6-minute epoxy to glue the pre-assembled ribs **W-4** and **W-5** to the main spar. Make sure the **W-4W** and **W-5W** face each other.

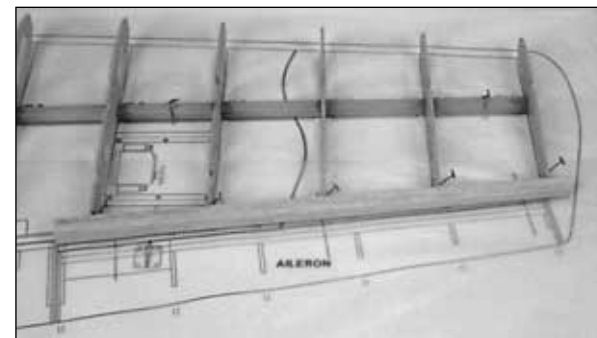

❑ 8. Glue the aileron wing TE assembly to the aft edge of ribs **W-8** through **W-12**. The upward facing edges of the ribs and the TE assembly should be flush. Make sure the jig tabs on the ribs are touching the building surface.

NOTE: The inboard end of the aileron TE extends approximately 1-1/8" inboard of rib **W-8**.

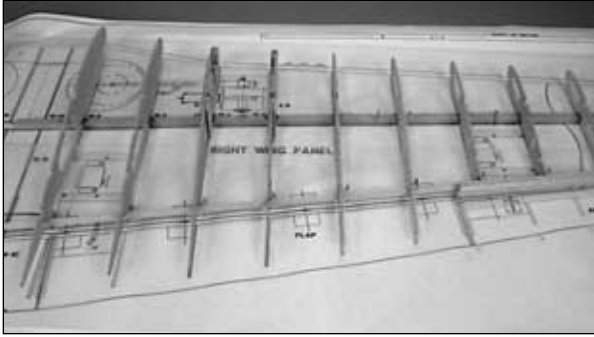

□ □ 9. Glue the lower 1/4" x 1/4" x 30" balsa **TE spar** as far forward as possible in the slots in ribs W-2 through W-8.

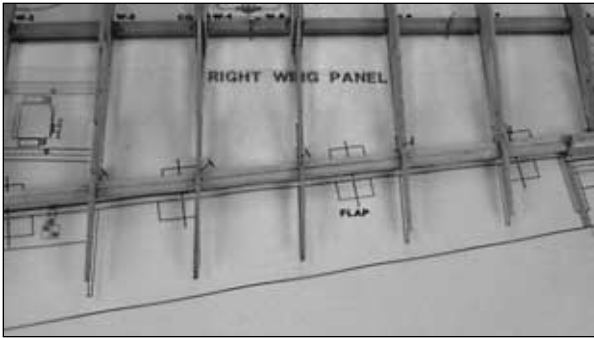

□ □ 10. Glue the lower 1/4" x 1/4" x 30" balsa **flap LE** into the **aft** portion of the slots in ribs W-2 through W-7, extending to but not glued to the aileron wing TE. There should be a 1/16" gap between the TE spar and the flap LE.

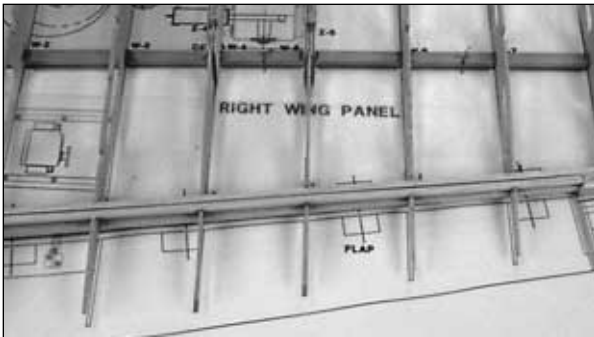

□ □ 11. Repeat steps 9 and 10 for the slot in the **upper** side of the ribs.

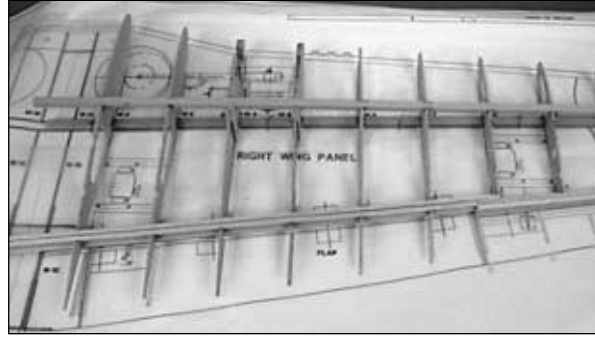

□ □ 12. Check the fit of the upper main spar in the wing ribs. Use 6-minute epoxy to glue the main spar to ribs W-4 and W-5. Use CA to glue it to the remaining ribs.

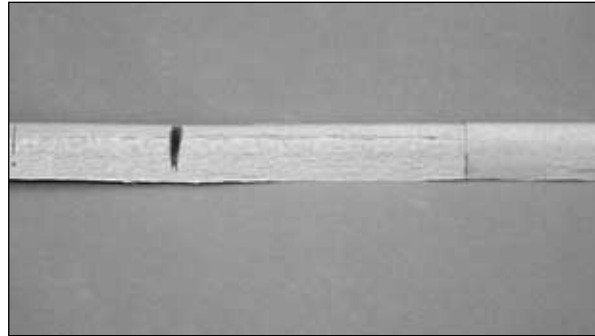

□ □ 13. Use a razor saw to put a V-notch in the shaped balsa **leading edge** to allow it to "bend" at W-4. Use the LE detail drawing on the wing plan for reference.

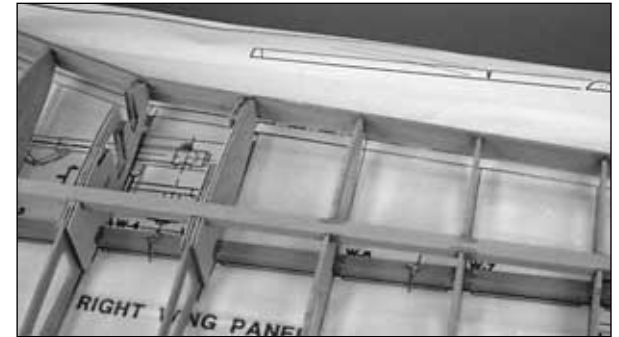
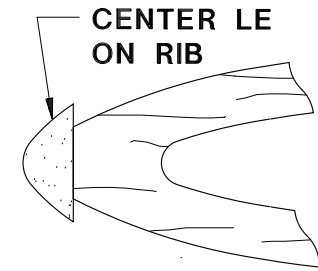

□ □ 14. Glue the shaped LE centered vertically on the front edge of the ribs.



□ □ 15. Cut a 17" long piece from four of the 3/32" x 3" x 24" balsa sheets. The 17" long sheet will be used as the aileron skins. The remaining 7" sheets are used to make **shear webs** to fit on the front of the main spar from rib W-3 to W-9 and the back of the main spar from W-3 to W-12. The grain of the shear webs run perpendicular to the spars and the shear webs must be glued securely to the spars. Make the remaining shear webs from the 3/32" x 3" x 30" balsa sheets.



☐☐ 16. Sight down the wing TE to make sure it is still straight. Shim any low jig tabs if required. From the 3/32" x 3" x 30" balsa sheets, make **aft shear webs** to fit on the **front** of the TE spars from rib W-2 to W-8. The shear webs must be glued securely to the TE spars.

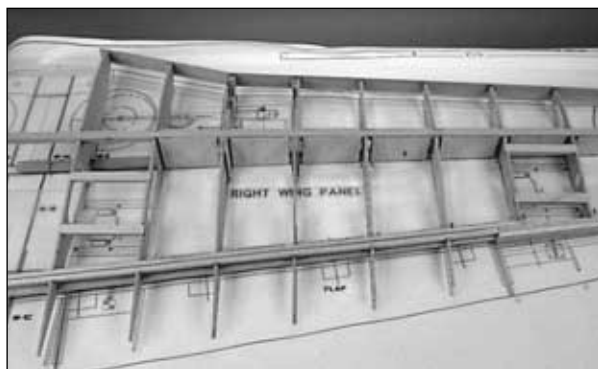

☐☐ 17. From the 1/4" x 1/2" x 32" basswood, make **hatch blocks** to fit in the notches from ribs W-2 to W-3 and W-8 to W-9. Use 6-minute epoxy to glue the hatch blocks to the ribs.



☐☐ 18. Use the die-cut 1/8" plywood **93P tool (93)** as shown to mark the ends of the spars and TE's.

NOTE: When marking the spars, the corner of the tool is on the wing centerline. When marking the TE spars and flap LE's, the corner of the tool is positioned where the TE spars end on the plan.

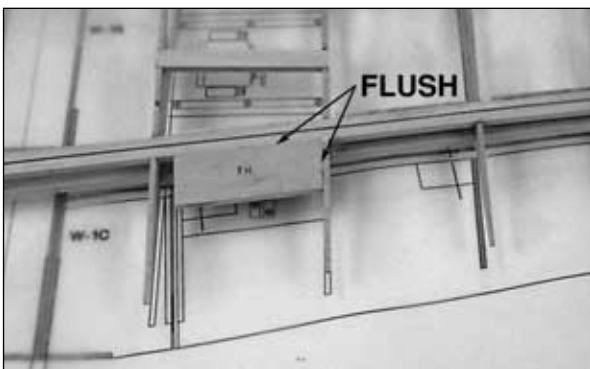

☐☐ 19. Glue together two of the die-cut 1/8" plywood **flap horn bases (FH)**. Glue the flap horn base in place between ribs W-2 and W-3. The base should be **flush** with the upward facing edge of the ribs and flap LE.

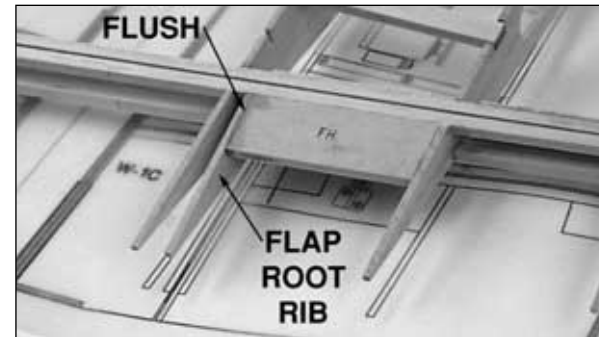

☐☐ 20. Glue the die-cut 1/8" balsa **flap root rib (FL1)** flush to the flap LE and flap horn base.

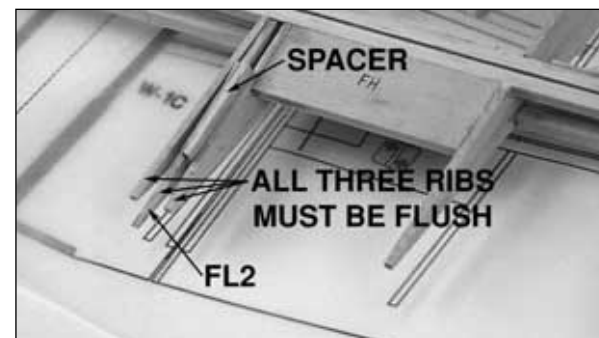

☐☐ 21. Cut a spacer from the leftover 3/32" and 1/16" die sheets. Place the spacers between the flap root rib (FL1) and the die-cut 1/8" balsa **flap root rib (FL2)**. Glue the flap root rib (FL2) to the flap LE making sure that the upward facing edge of FL2 is flush with the upward facing edges of FL1 and rib W-2. Glue a piece of leftover balsa between rib W-2 and FL2. This will keep FL2 properly spaced from rib W-2.



☐☐ 22. Cut eleven 1-1/4" long pieces from the 3/4" x 3/4" x 30" balsa stick to make **hinge point backups**. Glue the backups at the flap and aileron locations shown on the plan and sand them flush with the edges of the ribs.

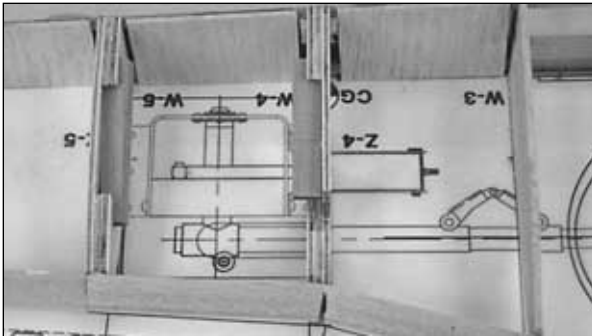

☐☐ 23. Cut the 1/4" x 1/2" x 12" maple stick to make the **retract rails**. Test fit the rails in the slots in W-4 and W-5. The edge of the W-5 rail should be flush with the side of rib W-5Z. Test fit the retract in the wing and trim the ribs and rails as

needed. The rails will need to be glued into the slots in the ribs at a slight angle so that the retract mounting flanges sit flat. You will need to trim the ribs appropriately.

☐☐ 24. Use 30-minute epoxy to glue the rails into the slots. Wipe off any excess epoxy that may squeeze out under the retract rails. Place the retracts on the rails so that the rails are glued in at the correct angle. Allow the epoxy to cure before removing the wing panel from the building surface.



☐☐ 25. From the 1/4" x 1/4" x 6" hardwood stick make **retract rail doublers**. The doublers fit under the retract rail in rib W-4 between the hole for the air cylinder.

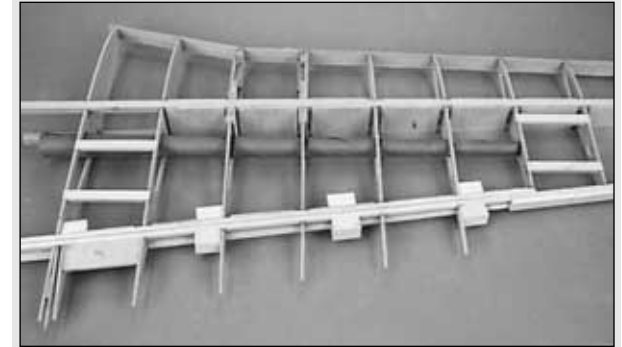

A. Cut a piece of paper slightly longer than the length needed to reach from the aileron servo bay to the wing root.

B. Roll the paper into a tube slightly smaller than the holes in the wing ribs. Use a couple of pieces of tape to hold the tube together.

C. Insert the tube into the holes in the ribs. Tack glue the tube to the ribs with CA.

NOTE: Try to store your wing panel on a flat surface with some weights on top of it until the wing panels are joined and sheeted, to prevent warping.

Repeat steps 1 through 25 to build the other wing panel.



HOW TO MAKE SERVO LEAD TUBES

When the aileron servos are mounted out in the wing, it can be difficult to run the servo wires through the ribs to the wing root. An easy solution is to make servo wire tubes.

JOIN THE WING PANELS

- ❑ 1. Trim and sand the ends of the spars, LE's and TE's of both wing panels flush with the tip rib **W-12**. Excess overhang will affect the dihedral angle.

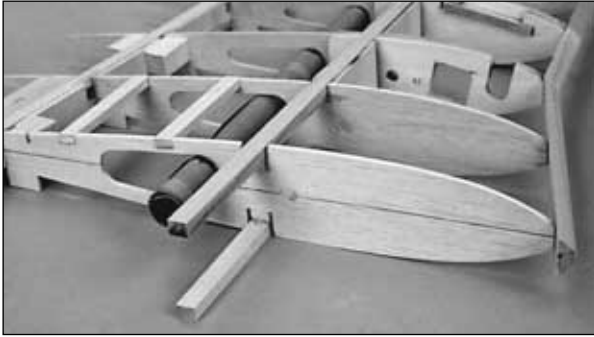

- ❑ 2. Draw a centerline on both W-2 ribs.

- ❑ 3. Trim all the spars at the wing root as they were previously marked with the 93P tool.

- ❑ 4. Trim off all the jig tabs except those on **W-2** and **W-12**. Use a small sanding block to "clean up" the area around the tabs. Also, sand all hinge point backups flush with the wing ribs.

- ❑ 5. Place the two 3/8" x 2" x 10" balsa **dihedral jig blocks** under the two W-2 ribs. Place the wing halves together upside-down. The spars at W-2 and the W-2 jig tabs should rest on the jig blocks. The tip ends of the spars and the W-12 jig tabs should rest on the building surface. (See the following photo).

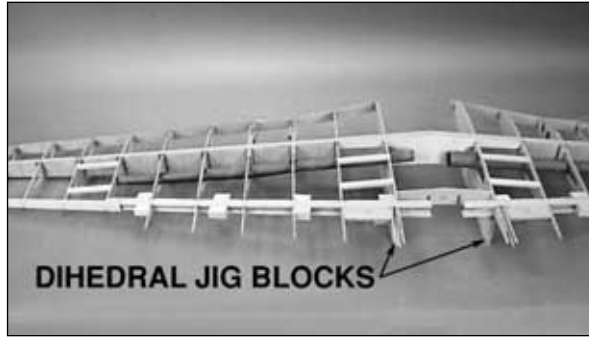

- ❑ 6. Test fit the wing panels on the jig blocks with the two die-cut 1/8" birch plywood **dihedral braces** in place. Insert the die-cut 1/8" birch plywood **aft cross brace (CB)** between the W-2 ribs. Adjust the parts until the panels meet at the spars. If the aft cross brace requires trimming, remove equal amounts from both ends.

- ❑ 7. Make two **equal** length sticks from leftover balsa to act as spacers between the two W-2 ribs. These should be positioned on the W-2 centerline. The length of these sticks will vary slightly, depending on how your spars are trimmed, but **7-1/4"** is a good starting point (see the following photo). These two sticks will make sure the W-2 ribs are parallel.



- ❑ 8. Test fit the aft cross brace and the sticks between the two W-2 ribs and adjust both sticks **equally** if adjustment is required. You may notice that the spars sweep forward slightly. This is normal.

- ❑ 9. When the wing fits on the jig blocks with the aft cross brace (CB) and the two equal length sticks in place, it is time to glue the wing panels together. Coat the mating surfaces of the spars and dihedral braces with 30-minute epoxy. Assemble the wing on the jig blocks. Use CA to **tack** glue the two equal length sticks into place. Apply 30-minute epoxy on the ends of the aft cross brace and insert into position. Use masking tape or adjustable clamps to hold the assembly together.

- ❑ 10. Glue 3/32" balsa shear webs to the dihedral braces between ribs W-2 and W-3.

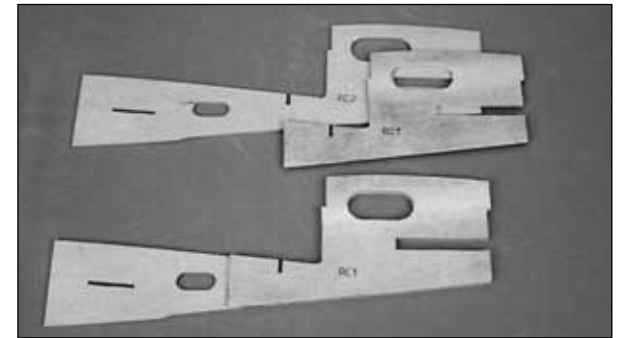

- ❑ 11. Align and glue the die-cut 1/8" plywood **radiator frames RC-1** to the die-cut plywood **sub frames RC-2**. Be sure to make a **left and right**

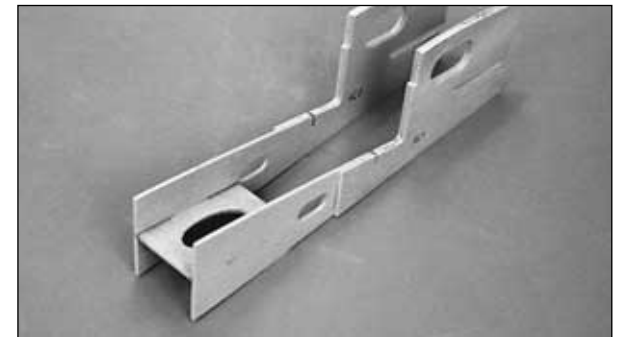

- ❑ 12. Insert the die-cut 1/8" plywood **center tray** between the two RC-2's. Make sure the front edges are aligned. Use a 90P triangle to hold each RC assembly vertical while you glue it to the center tray.

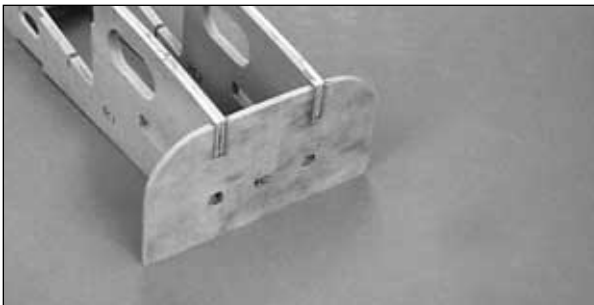

❑ 13. Insert the die-cut 1/8" plywood **F-8C** into the aft end of the radiator assembly. Make sure all the edges are square and properly aligned. Make small adjustments to the notches if required. Use a 90° triangle to hold the radiator assembly vertical while you glue it to F-8C.

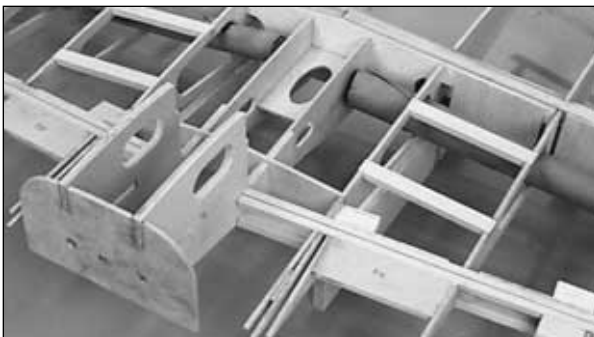

❑ 14. Remove the rear stick. Work the assembly into position in the center of the wing. Trim the aft spars and flap LE, if necessary, to fit the assembly.



❑ 15. Notice that the die-cut ribs RC-1, in the assembly are undersized 3/32" (except in the area

around the top of the center tray) to allow for a center doubler of 3/32" balsa center sheeting. Put marks 1-1/8" on each side of the dihedral brace centerline to help in the alignment of the center assembly.

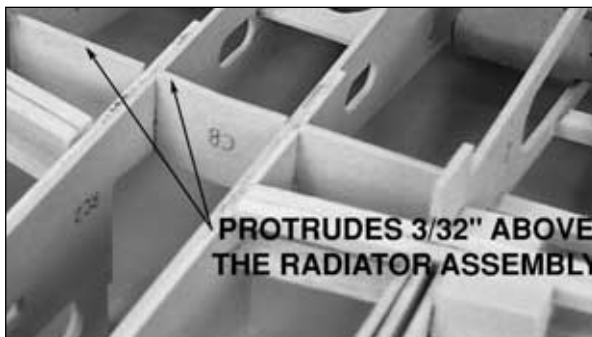

❑ 16. Use 6-minute epoxy to glue the front of the radiator assembly in position by aligning the top edge of the assembly with the top of the dihedral brace and the marks you made in the previous step.

NOTE: The word "top" refers to the top surface of the wing. The aft cross brace should protrude about 3/32" above and below the edges of the RC-1 ribs to allow for the double sheeting. Wipe off any excess epoxy on the top and bottom of the radiator frame before it cures.

❑ 17. Trim the length of the 1/4" plywood beveled edge wing bolt plate until it fits between the two W-2 ribs near the centerline.

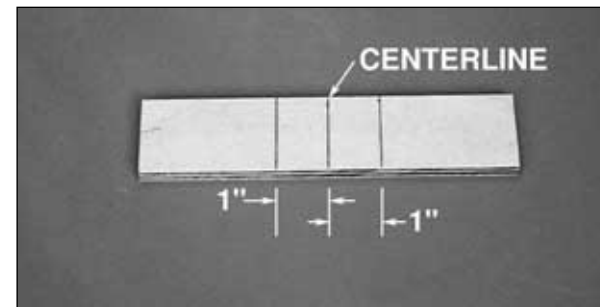

❑ 18. Mark a centerline on the wing bolt plate. Mark a line offset 1" on **both** sides of the centerline.

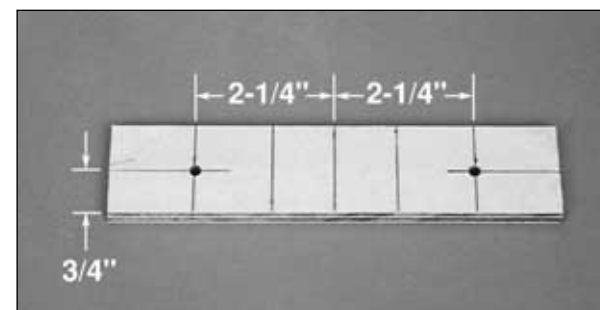

❑ 19. Mark a line offset 2-1/4" on **both** sides of the centerline. Draw a line perpendicular to the centerline 3/4" from the angled edge. Drill 13/64" pilot holes at the intersection of the lines.

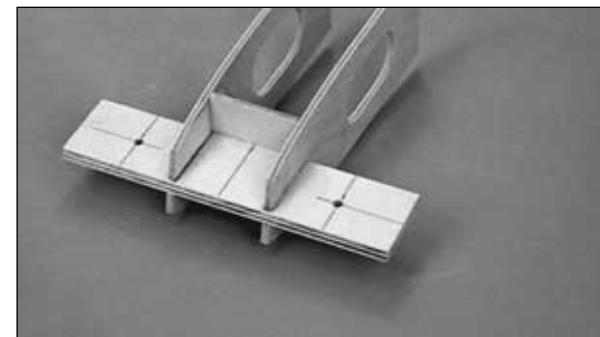

❑ 20. Glue together the two die-cut 1/8" plywood **W-1A's**, the die-cut 1/8" plywood **front spacer plate** and the wing bolt plate as shown. Use a 90° triangle to check the alignment as you glue.

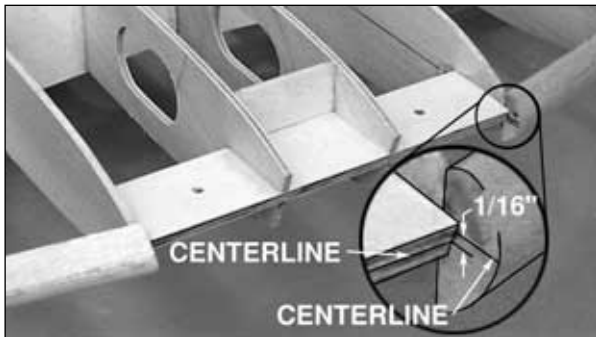

21. See the cross section at W-1 on the fuselage plan for the proper orientation of the angle on the front of the W-1A ribs. Use 6-minute epoxy to glue the forward assembly between the two W-2 ribs. The aft edges are centered on the front face of the dihedral brace (the W-1A ribs are undersize to allow for double sheeting). The front of the assembly is located by placing the center of the 1/4" wing bolt plate 1/16" below the centerline of the W-2 ribs (toward the bottom surface of the wing).

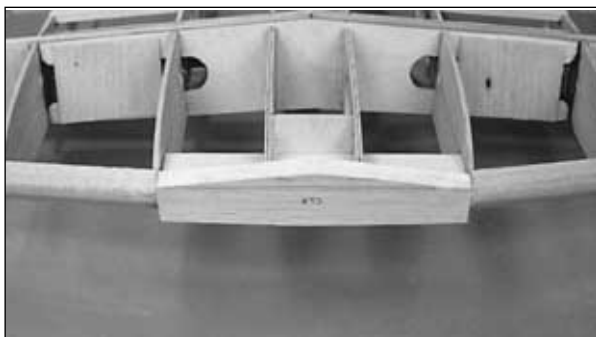

22. Glue the two die-cut 1/4" balsa **center LE's (CLE)** together. Trim the CLE to fit between the two wing LE's in front of the wing bolt plate. Glue the CLE in place. You may rough contour them now, but wait to do the final sanding until after the wing has been sheeted.

SHEET THE BOTTOM OF THE WING

1. Sort through the remaining 3/32" x 3" x 30" wing sheeting. Pick out the best 3 sheets and set them aside for the top of the wing. Also, from the 3/32" x 3" x 42" balsa wing sheeting, pick out the best 6 sheets and set them aside for the top of the wing.

2. Notice that the center wing rib W-1 is 3/32" undersize everywhere but on top of the center tray. This is to allow you to put 3/32" center sheeting over the W-1 ribs to reinforce the center-section.

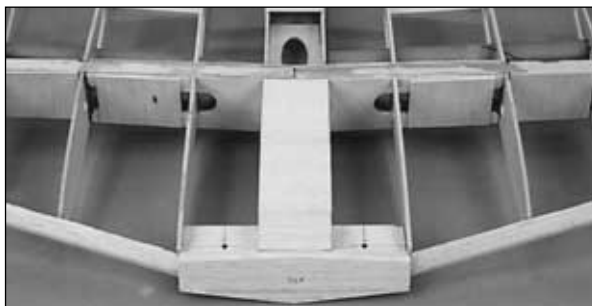

3. Use a piece of 3/32" x 3" x 30" balsa sheet to sheet the top and bottom of the two W-1 ribs (except on top of the center tray).

NOTE: This is a somewhat unique way of joining the sheeting in the center of the wing that eliminates the need for glassing the center section. Do not try to sand the center sheeting so the wing skin will have 100% contact with it. If the skin is left a little high on the top surface of the wing, it is fine, since this part of the wing is hidden inside the fuselage.



4. Glue the 1/4" x 1/4" balsa wing TE spars and the flap LE's to the radiator frame. Make sure the TE's and LE's are flush with the center sheeting.

5. Glue 3/32" balsa shear webs to the front of the 1/4" x 1/4" balsa wing TE spars, between the radiator frame and W-2 ribs.

6. Sand the center sheeting slightly, particularly on the bottom, to blend it with the shape of the other wing ribs.

NOTE: The wing sheeting process described here involves first making a skin that covers most of the wing before gluing it to the structure. This skinning process requires fairly quick and accurate work when you apply the skin to the wing. We recommend you read through the entire sheeting section before proceeding.

7. Cover your flat, smooth building surface with waxed paper or Plan Protector. You will join the wing skins on this surface.

8. Use a long sanding bar with 150-grit sandpaper to sand the tops of the bottom spar, wing TE spars and ribs so they all smoothly blend together. Make sure the tops of the TE spars match the tapering angle of the ribs sanding the ribs lightly to maintain the designed airfoil shape.

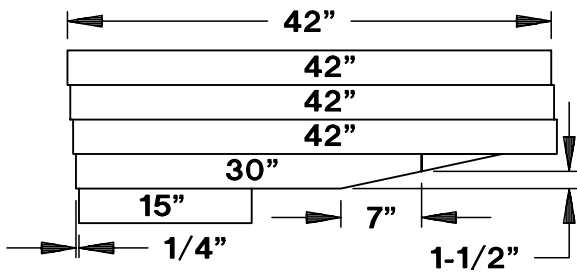

❑ 9. Cut one 3/32" x 3" x 30" balsa sheet in half (two 15" lengths). Make four wing skins by edge gluing three 3/32" x 3" x 42" balsa sheets, one 3/32" x 3" x 30" balsa sheet and the previously cut 3/32" x 3" x 15" balsa sheet allowing a 1/4" off-set at the end of each sheet. Cut off the corner of the 30" sheet and glue it as shown in the sketch.

❑ 10. Lightly sand both sides of the wing skins with a long sanding bar and fresh 220-grit sandpaper.

NOTE: The steps below show sheeting the flaps with a separate piece of sheeting. This orients the grain more parallel with the flap span and makes it easier to fit.

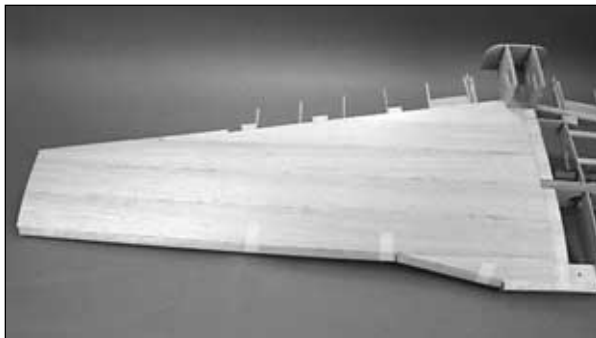

❑ 11. Tape a wing skin to the bottom of the wing structure, aligning it with the LE and the center of the wing. Mark the location of the outer side of rib W-12, the gap between the wing TE spar and the

flap LE and the aileron TE assembly. You will need to cut out around the radiator frame. We usually leave about 3/8" overhang where possible. Use a piece of the sheeting you trimmed off to fill in the angled area along the LE.

❑ 12. Trace the shape of the skin onto the other bottom skin and the two top skins. It is not an exact match, but this will offer an excellent starting point.

❑ 13. Position the wing upside down on the jig blocks. You may want to tack glue the jig to the building surface to keep it from moving.



❑ 14. Position the front of the sheet against the LE. Glue it in position with thin CA.

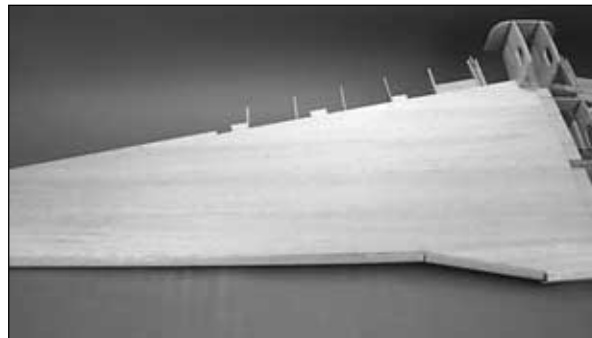

❑ 15. Carefully lift the wing skin away from the ribs. Apply a bead of thick CA to the top of the ribs, the main spar, the edge of the center sheeting, aileron wing TE assembly and the wing TE spar. **Do not** glue the wing skin to the flap LE. Press the wing skin down and hold it in position with weights or masking tape until the CA cures.

❑ 16. Repeat the process to install the second bottom wing skin.

❑ 17. Turn the wing over and check all the glue joints applying CA where needed.



❑ 18. Trim the bottom skins along the gap between the wing TE spar and the flap LE.



❑ 19. From 3/32" balsa sheeting remaining from the stab and shear webs, sheet the area along the side of the radiator frame.

NOTE: Leave the wing on the jig blocks until you are ready to sheet the top of the wing. This allows less time for moisture and stress to twist the wing.

SHEET THE TOP OF THE WING

❑ 1. Trim any remaining jig tabs from the top of the wing. Use a long sanding bar to remove any high spots and excess glue.

❑ 2. Pass a 13/64" drill bit through the holes in the wing bolt plate, drilling through the bottom skin to eliminate any problems finding the holes later.

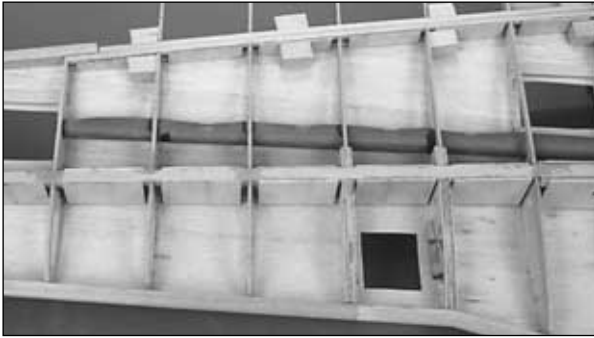

❑ 3. Use a sharp hobby knife to roughly cut out the openings for the aileron servos, flap servos and retract gear.

❑ 4. With the top of the wing still open, now is the best time to install the retract air tubing. Make a small hole in the center sheeting to allow the pressure tubing to exit the wing. To assist in the installation of the aileron and flap servos, route pieces of string through the tubes in the ribs, into the center tray compartment. Later, when the servos are installed, the string can be used to pull the servo leads through the ribs.

❑ 5. Fit the top balsa wing skin to the wing.

NOTE: The top wing skin may be glued on in one of two ways: You may glue the skin to the wing structure all at once as you did when sheeting the bottom, or you may use the following procedure.

❑ 6. Tape the wing skin to the LE in a few places. Use thin CA to glue the skin to the LE.

❑ 7. Set the wing horizontally on the table and lift the TE so the wing tilts forward at about 45%.

❑ 8. Working rapidly, put a stream of medium CA on each rib at the spar and allow it to run forward down the rib to the LE. Put a bead of medium CA on the spar.

❑ 9. Hold the wing vertically on one wing tip and, starting at the middle, roll the wing skin back onto the wing. By holding the wing on its tip and putting equal pressure on both sides of the wing, the wing will retain its proper shape and washout.

❑ 10. Apply medium CA on the aft portion of the ribs and the TE's. Hold the wing vertically on its tip again and press the aft portion of the wing skin onto the structure.

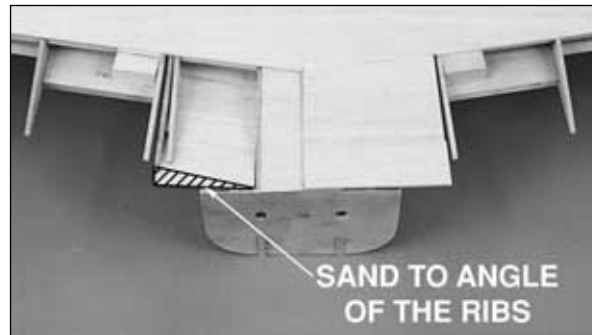

❑ 11. Lightly sand the bottom wing skin on the side of the radiator frame to match the angle of flap root rib FL-2. Use a 3/32" x 3" x 30" balsa sheet to finish the areas of the top wing that are not covered by the main skin.

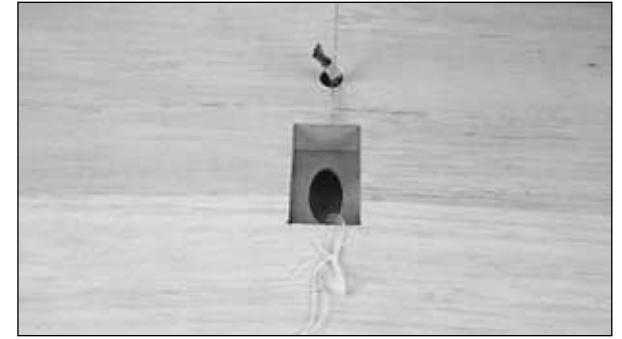

❑ 12. Carefully trim the sheeting over the center tray and the opening for the pressure tubes.

❑ 13. Trim the top wing skins along the gap between the wing TE spar and the flap LE.

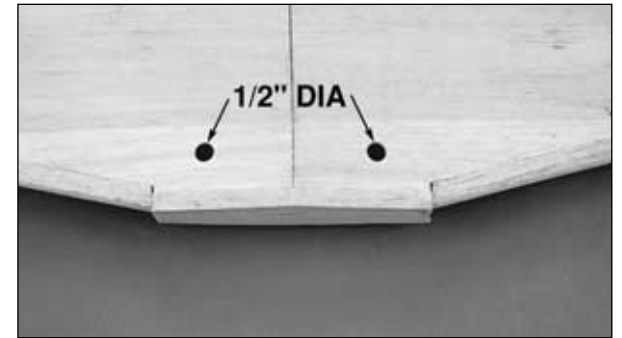

❑ 14. Enlarge the holes where the wing bolts pass through the skins to approximately 1/2" in diameter.

❑ 15. Sand the top and bottom wing skins flush with the aileron wing TE assembly.

❑ 16. Sand the LE flush with the top and bottom wing skins. Don't worry about shaping the LE at this time.

BUILD THE AILERONS

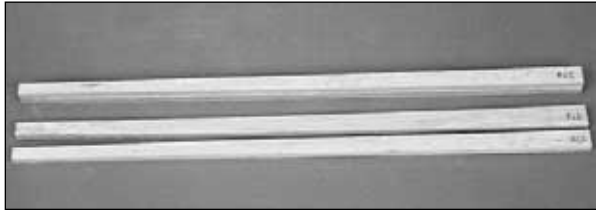

1. Glue the die-cut 1/4" balsa **aft LE (ALE)** centered on the die-cut 1/4" balsa **forward LE (FLE)**.

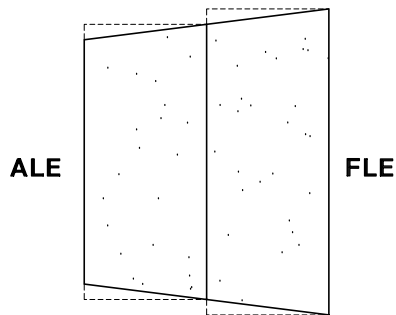

2. Use a razor plane and sanding bar to blend the edges of ALE and FLE.

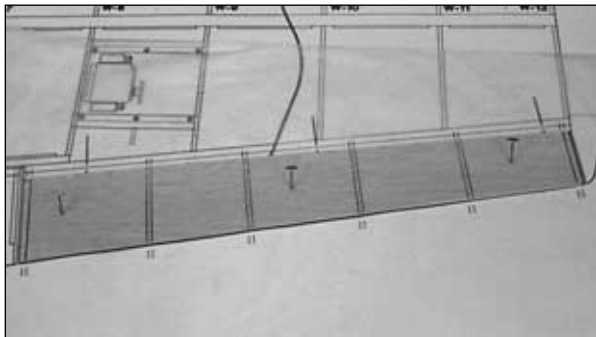

3. From a precut 3/32" x 3" x 17" balsa sheet make an **aileron bottom skin**. Remember, you cut the sheets when making the shear webs. Use the aileron pattern on the plan as a guide. Use the rib guides on the plan to mark the rib location on the bottom skin.

NOTE: The aileron skin goes from the outside of

rib **A-1** to the outside of rib **A-6**. After the top and bottom skins are applied, a 3/32" balsa cap is installed on both ends of the ailerons. Save the excess sheeting to make the aileron end caps.

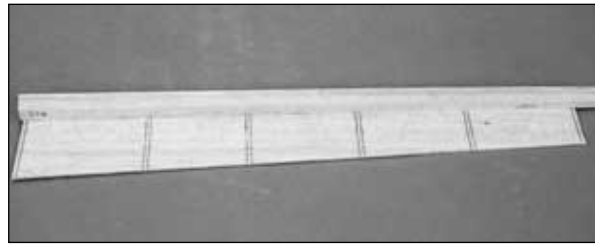

4. Glue the aileron LE flush with the forward edge of the bottom skin. The wider end of the LE goes on the wider end of the aileron skin. The aileron LE is longer than what is required. The excess will be removed later.

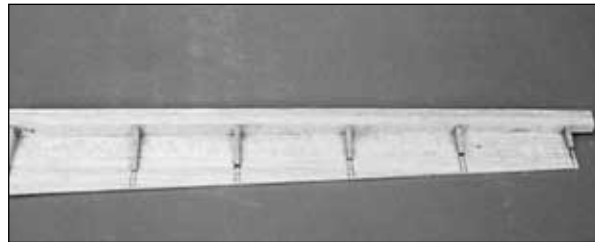

5. Glue the die-cut 1/8" balsa ribs **A-1** through **A-6** perpendicular to the aileron skin.

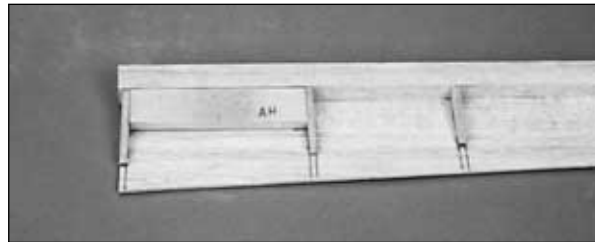

6. Glue together two of the die-cut 1/8" plywood **aileron horn bases (AH)**. Glue the aileron horn base in place between ribs A-1 and A-2. The base should be **flush** with the upward facing edge of the ribs.

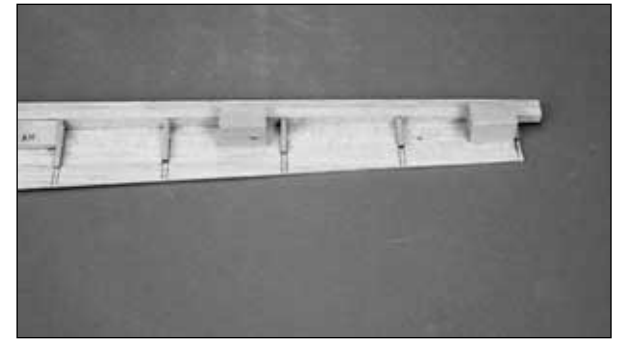

7. Cut two 1-1/4" long pieces from the 3/4" x 3/4" x 30" balsa stick to make hinge point backups. Glue the backups at the locations shown on the aileron plan.

8. Use a razor plane and sanding bar to blend the LE and hinge point backups flush with the upward facing edge of the ribs. Sand the TE of the aileron skin to the same angle as the ribs.

9. Glue a second 3/32" x 3" x 17" balsa sheet to the top of the aileron LE, ribs, hinge point backup and bottom aileron skin. After installing this skin, mark it as "bottom."

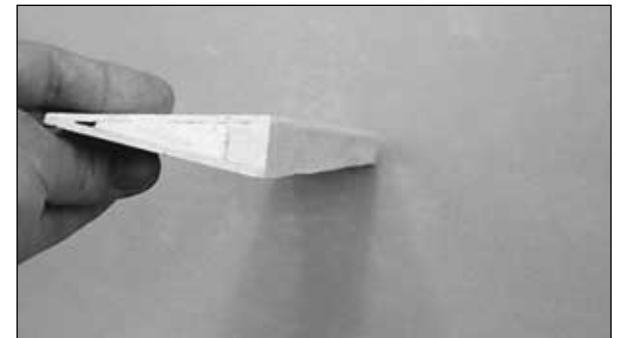

10. Trim and sand the top aileron skin flush with the LE and bottom skin TE. Sand the ends of the LE and aileron skins flush with the outside of ribs A-1 and A-6.

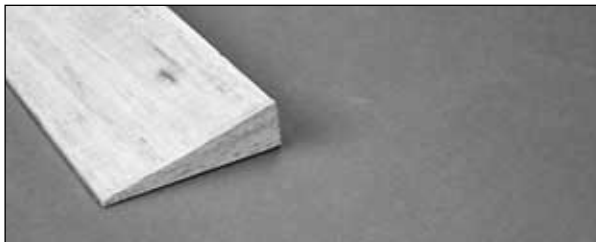

☐ ☐ 11. Use the excess $3/32$ " balsa trimmed from the aileron skins to make **end caps** on the ailerons.

☐ 12. Return to step 1 and construct the other aileron.

NOTE: Make sure to construct it over the other aileron plan so that you have a left and a right aileron.

INSTALL THE WING TIPS

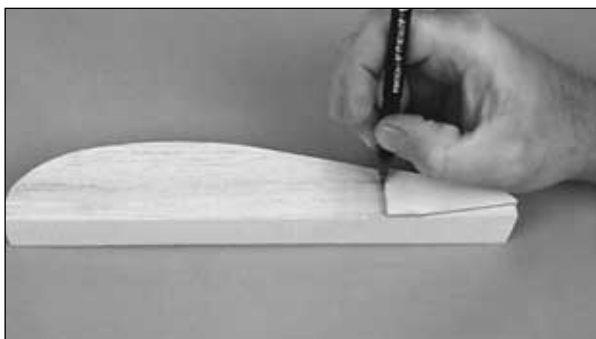

☐ 1. Place the die-cut $1/8$ " plywood **wing tip brace** on the aft end of the shaped $3/4$ " balsa **wing tip**. Mark the location of the wing tip brace on all four wing tip sections.

☐ 2. Glue two of the wing tip sections together to make wing tips that are $1-1/2$ " thick. **Do not** apply glue in the area of the wing tip brace.

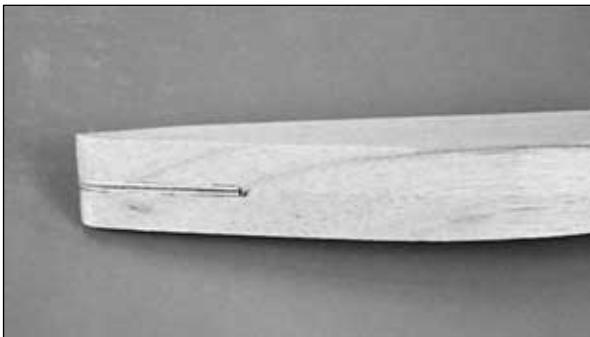

☐ 3. Saw a $1/8$ " slot along the joint of the wing tips and glue the braces in the slots with CA. Sand the aft end of the wing tip to match the shape of the wing tip brace.

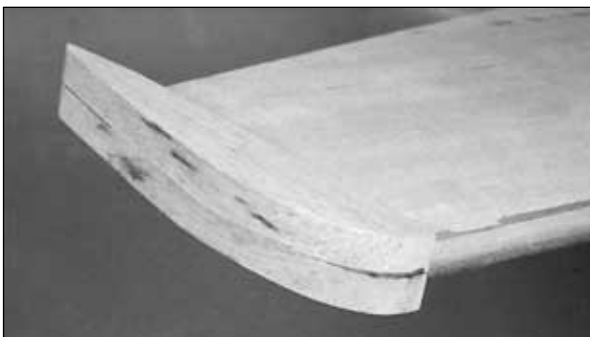

☐ 4. Glue the wing tips onto the wing, carefully centering the tip brace at the TE. Use a knife, razor plane and sanding bar to shape the wing tips.

BUILD THE FLAPS



☐ ☐ 1. Tape the aileron to the wing with a $1/16$ " gap between the ailerons and the wing tips.

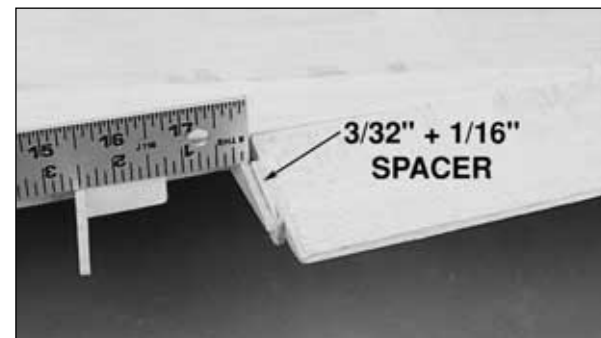

☐ ☐ 2. Place the $3/32$ " + $1/16$ " spacer, used when installing ribs FL-2, on the root of the aileron. Lay a straightedge on top of the flap ribs and glue the die-cut $1/8$ " balsa **flap rib (FL-3)** to the $1/4$ " balsa flap LE. Remove the spacer after the glue has cured.

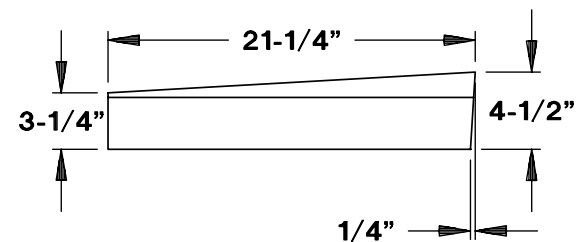

☐ ☐ 3. Cut a $3/32$ " x 3 " x 30 " balsa sheet in half lengthwise. Glue a half sheet and a full sheet

together edgewise to make two flap skins $3/32"$ x $4-1/2"$ x $30"$. Trim the flap skins following the drawing. Save the excess balsa sheet to make the flap end caps.

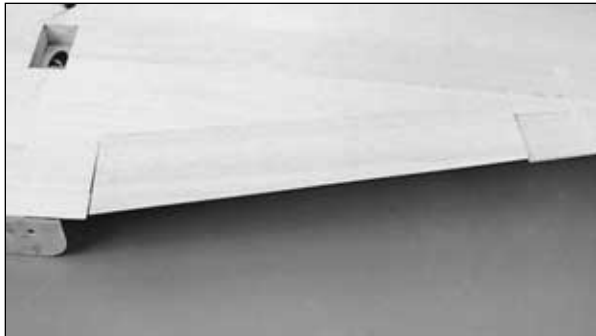

❑❑ 4. Fit the top flap skin flush with the front of the $1/4"$ flap LE and slightly overhanging flap ribs FL-1 and FL-3. Glue the top skin to the flap LE and the top of the ribs.

❑❑ 5. Turn the wing over and carefully cut the flap loose from the wing.

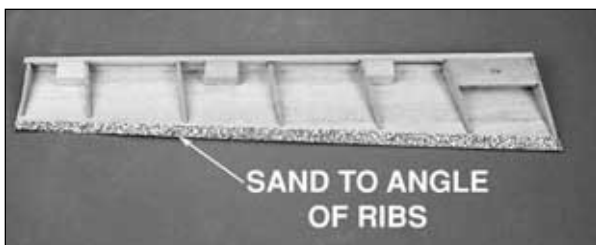

❑❑ 6. Set the flap on the edge of a table and carefully sand the ribs flush with the $1/4"$ balsa flap LE. Sand the TE of the top skin to match the angle of the ribs.

❑❑ 7. Place the flap on your flat building surface with the top skin down. Glue the bottom skin to the LE, rib edges and the TE of the top skin.

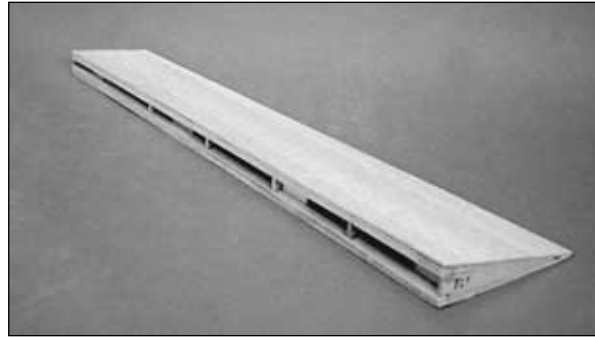

❑❑ 8. Sand the ends of the $1/4"$ LE's and the top and bottom flap skins flush with ribs FL-1 and FL-3. Also, sand the forward edge of the $1/4"$ LE's flat.

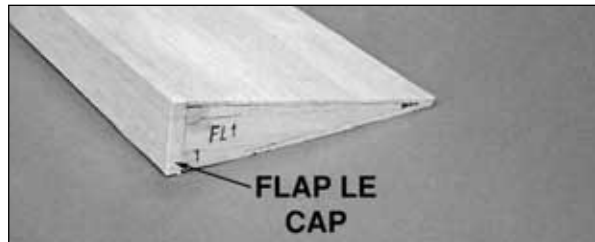

❑❑ 9. Mark the bottom of the flap. Glue the $1/4"$ x $1-1/4"$ x $24"$ balsa **flap LE cap** centered on the forward edge of the flap. Sand the LE cap flush with the top and bottom skins and ribs FL-1 and FL-3.



❑❑ 10. Glue leftover $3/32"$ balsa sheeting to the ends of the flap to make **end caps**. Sand the end caps flush with the LE and the flap skins.

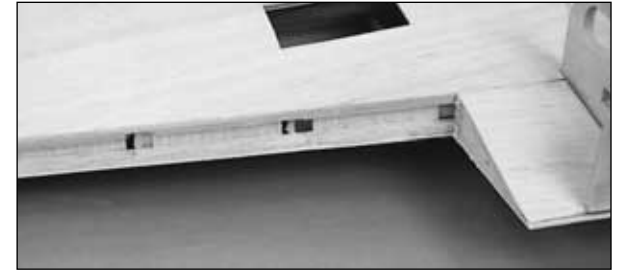

❑❑ 11. Use a Dremel® MultiPro™ with a drum sander or sandpaper wrapped around a dowel to sand the ribs flush with the shear webs inside the $1/4"$ TE spars. Use a sanding bar to true up the aft edge of the wing sheeting at the flap.



❑❑ 12. Study the flap cross-section on the plan. Notice the concave shape of the trailing edge of the wing. Use dowels of appropriate diameters to sand the proper hemispherical shape into the TE of the wing. Be careful not to sand into the TE shear webs.

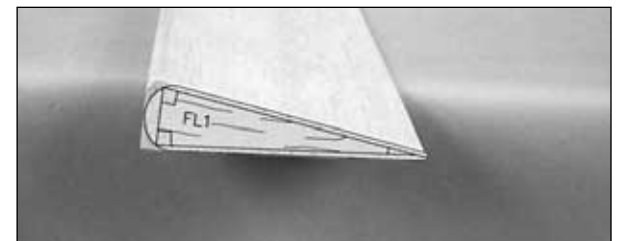

❑❑ 13. Cut out the flap cross-section patterns from the plan and attach them to the end of the flaps. Sand the LE to the shape of the flap pattern. Trial fit the flap to the wing frequently to check the fit. You should be able to align the flap TE with the aileron TE and have a slight gap at the hinge line.

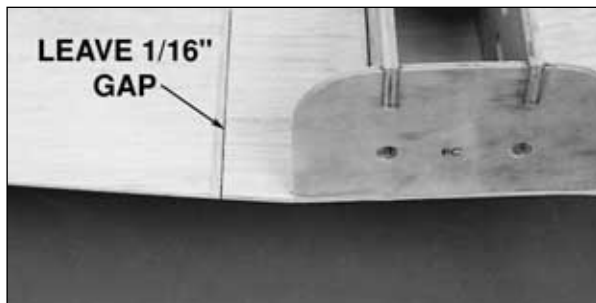

14. Tape the flap to the wing. Sand the TE of the wing to match the flap TE angle. Leftover balsa sheet can be used to fill any gaps between the wing sheet and former 8-C.

15. Go back to step 1 and repeat the process to build the other flap.

BUILD THE FUSELAGE

BUILD THE FUSE SIDES

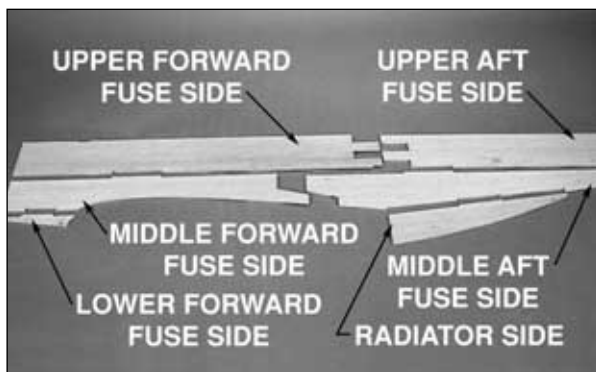

1. Test fit the die-cut 3/16" balsa **upper forward fuse side**, **upper aft fuse side**, **middle forward fuse side**, **middle aft fuse side**, **lower forward fuse side** and **radiator side** together. These should be aligned over the fuselage side view on the plan or by placing a long straightedge along the top edge of the upper parts. Adjust any joints that do not fit well.

2. Place wax paper or Plan Protector over your work surface. Reassemble the parts over the plan and check their alignment. For a straight fuselage, it is important to have the fuse sides straight and identical. Use thin and medium CA to glue the parts together. Use a quick wipe with a paper towel to remove excess glue, as this will make sanding easier. Keep in mind that you are making a left and a right fuselage side.

3. Inspect the two fuselage sides. Choose the right and left sides so the best surfaces will face outward. Mark the **inside** of the appropriate part **RI** and **LI** (for **right inside** and **left inside**). Sand both sides of the fuselage sides to smooth out the joints.

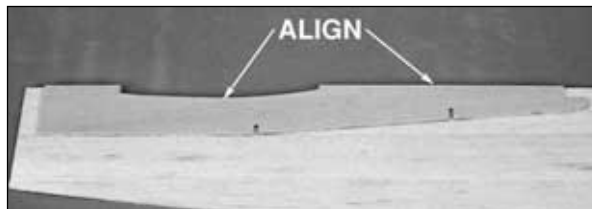

4. Glue a die-cut 1/8" plywood **aft fuse doubler** to the **inside** of each fuselage side. **Be sure to make a left and a right side**. Align the stab saddle and the top edge of the doubler with the fuse side when gluing.

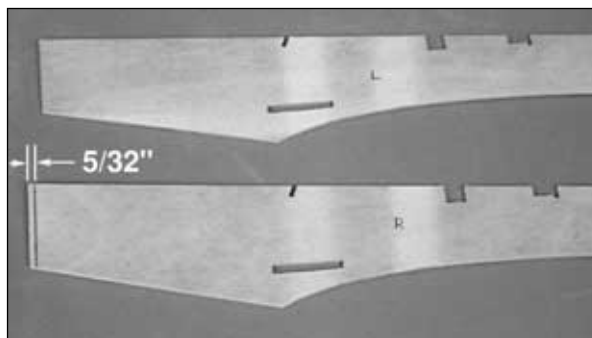

5. On one of the die-cut 1/8" plywood **fuse doublers** draw a line 5/32" back from the forward edge. Trim the fuselage doubler to this line. Mark this doubler "R" (right) and the other doubler "L" (left). This will set the right thrust in the firewall.

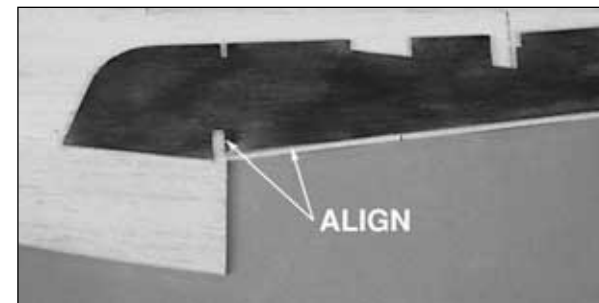

6. Line up the fuse doublers using the notch at the **back** of the wing saddle as the primary reference. Be sure to put the right fuse doubler on the inside of the right fuse side. Glue both doublers in place.

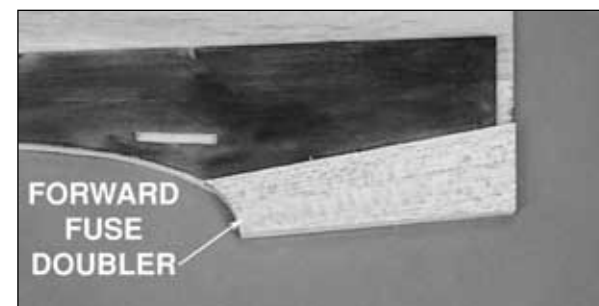

7. Glue the die-cut 1/8" balsa **forward fuse doublers** in place. They should touch the plywood fuse doublers.

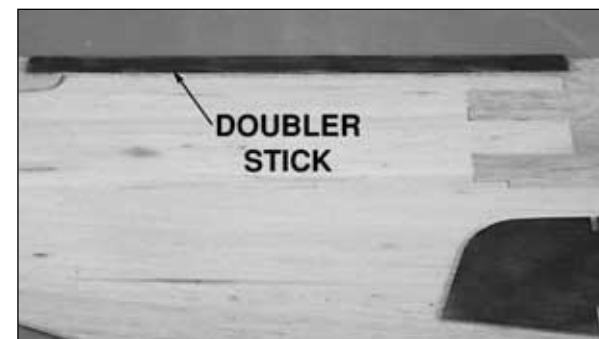

8. Cut two 11-5/8" long **doubler sticks** from the 1/8" x 1/2" x 24" balsa stick. Glue the doubler sticks along the top edge of each fuse side beginning at the notch in the aft fuse doubler.

❑ 9. Tape the fuselage bottom view over your flat building surface (we recommend cutting that part of your plan loose to make it easier to handle). Cover the bottom view with wax paper or Plan Protector.

IMPORTANT: You are building the fuselage upside-down over the bottom view. This aircraft has right thrust built into the firewall. Since the fuse is built upside-down, this will appear to be left thrust until the fuse is flipped over. Just follow the instruction sequence and the fuse will be correct.

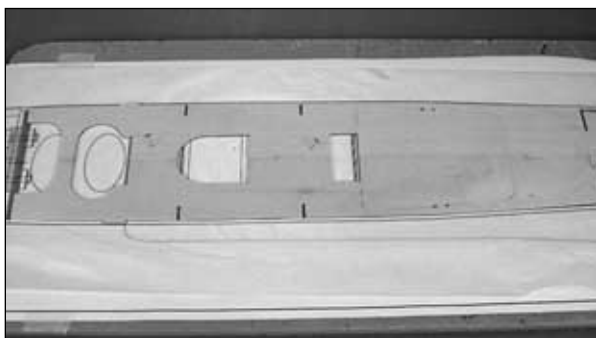
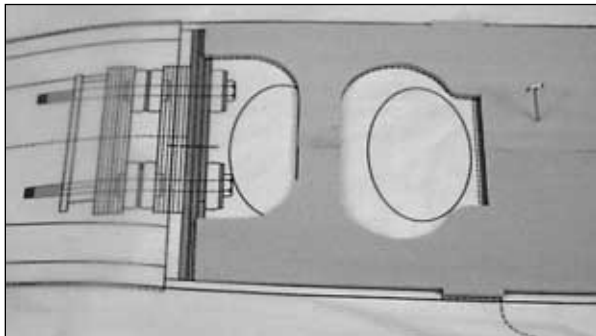

❑ 10. Cut off the forward edge, along the embossed line, of one of the two die-cut 1/8" plywood **forward crutches**. Glue the two crutch halves together. Pin the forward crutch over its location on the plan. Make sure the front of the crutch matches the plan for the correct thrust angle.

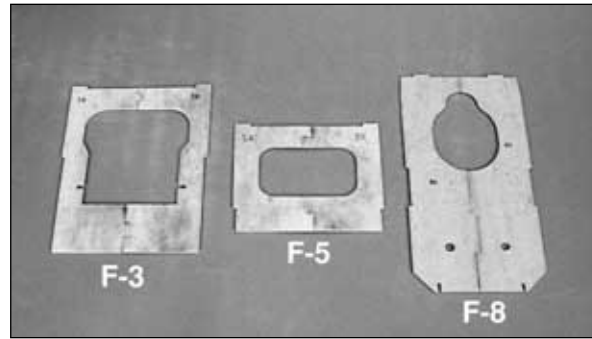

❑ 11. Glue the die-cut plywood formers **F-3A** and **F-3B** together, **F-5A** and **F-5B** together and **F-8A** and **F-8B** together.

NOTE: Some of the formers are not symmetrical and must be glued in with the proper orientation. Glue in all the formers with the embossed numbers facing toward the **front** of the model.

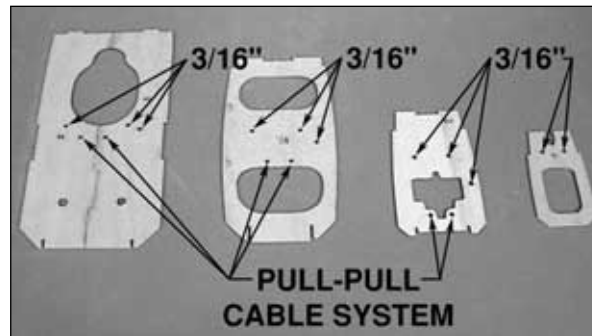

❑ 12. Drill 3/16" holes through the punch marks at the locations shown in formers F-8, F-9, F-10 and F-11. These holes are for mounting the outer pushrod tubes. The remaining two punch marks are for the pull-pull tail wheel steering cable and should be drilled to match the size of the outer cable tube.

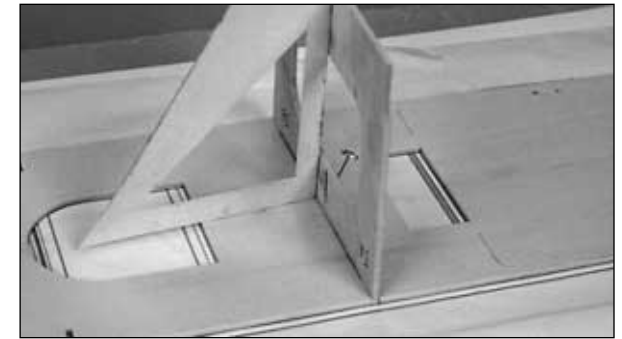

❑ 13. Glue the die-cut 1/8" plywood former F-5 to the forward crutch at its location on the plan. It should be perpendicular to the crutch with its embossed number facing forward.

❑ 14. Place the die-cut 1/8" plywood former F-3 in its slot, but do **not** glue it in place since the forward slant is set by the fuse sides.

NOTE: It is helpful to keep some weights on the crutch while building the fuselage to keep it flat on the table.

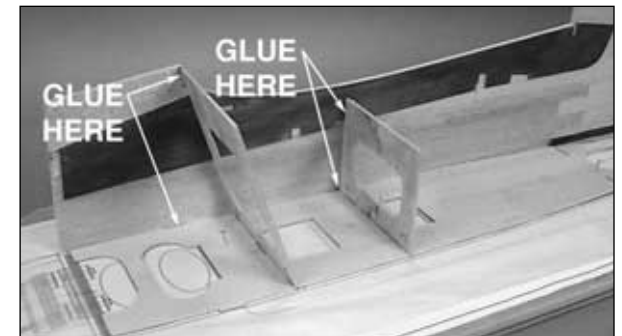

❑ 15. Place the left fuse side in position. Make sure its top edge is against the building surface and tack glue it at the following places: at the notch near the front of the crutch; at the bottom edge of former F-3 near the front of the wing saddle; at the top and bottom of former F-5. Also glue former F-3 to the crutch.

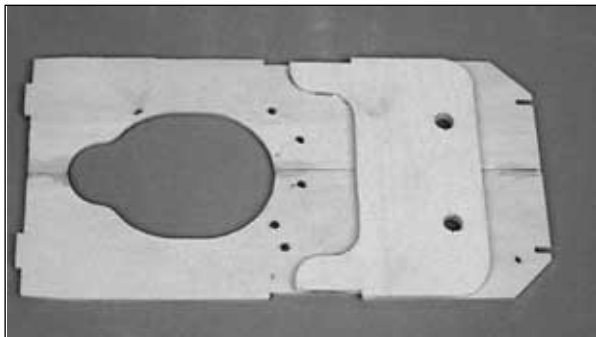

16. Use 6-minute epoxy to glue the die-cut plywood **sub-former F-8D** to the aft face of former **F-8A/B**. Make sure the 3/8" holes line up. This assembly is now called F-8.

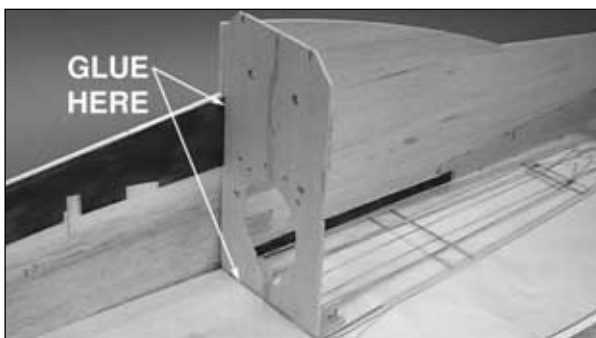

17. Glue former F-8 to the crutch and tack glue it to the plywood doubler near the notch.

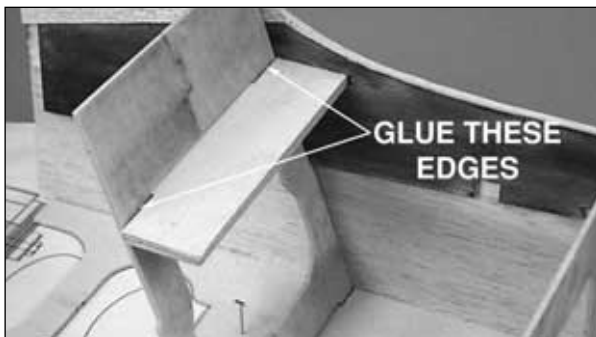

18. Test fit the 1/4" **fuselage bolt plate** into the fuselage. It may be necessary to bevel the forward outboard edges slightly to provide an interference-free fit.



19. Fit the right fuselage side into place. Check that all the notches fit properly or make adjustments. Make sure the tip edges of the fuse are against the building surface.

20. Use 6-minute epoxy to **securely** glue the fuselage bolt plate to the fuse sides and former F-3. Before the epoxy cures, use CA to glue formers F-3 and F-5 to the right side and finish gluing them to the left fuselage side. Glue the fuse sides to the crutch from the notch in front of former F-3 to former F-5. Make epoxy fillets around the bolt plate.

21. Glue former F-8 to both fuselage sides from the wing saddle area to the middle of F-8. Do not glue it near the crutch area.



22. Glue the die-cut 1/8" plywood **former F-7** to the fuse sides at the front of the servo rail notches.



23. Glue 3/8" x 30" triangle reinforcements at the joints between former F-3 and the balsa fuse sides, F-5 and the balsa fuse sides and the crutch and the balsa fuse sides between formers F-3 and F-5.

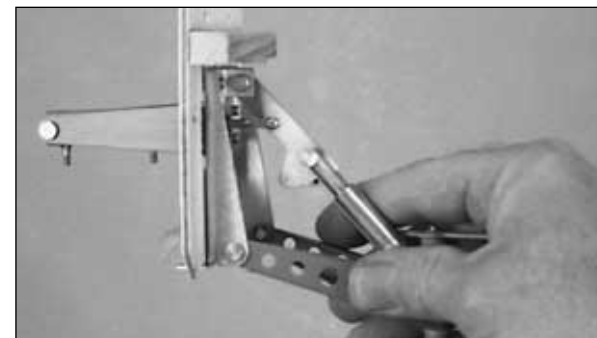

24. For the Robart retractable tail wheel (ROBQ2225 not included) use 6-minute epoxy to glue the **retractable tail wheel rails**, cut from the 3/8" x 1/2" x 7-1/2" basswood stick, to the die-cut 1/8" plywood **former F-10**. It's best to glue the bottom rail on first, let the epoxy cure, place the retractable tail wheel on the bottom rail and glue the top rail in place. This will give you the best fit.

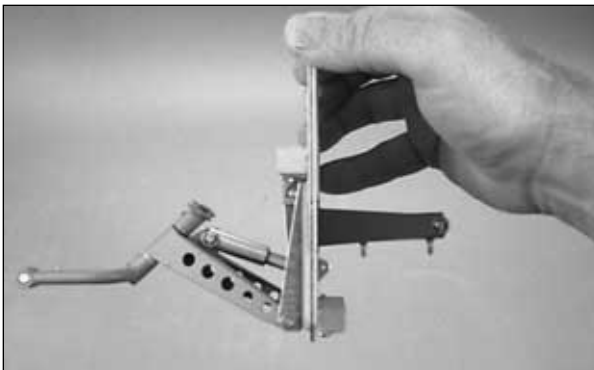

☐ 25. Position the retractable tail wheel on the rails and mark the mounting hole locations. Drill a 7/64" pilot hole at each mark. Attach the retractable tail wheel to the rails with #6 x 1/2" sheet metal screws. Check that the former does not interfere with the movement of the retractable tail wheel.



☐ 26. Use 30-minute epoxy to glue former F-10 to the fuse sides. It should be located using the notches in the aft fuse doublers. Work a piece of masking tape under the fuse and use it to pull the fuse sides against the former. Make sure F-10 is perpendicular to the building surface and the fuse is aligned over the fuse plan. Use a couple of T-pins to hold it in place.



☐ 27. Use medium CA to glue former F-9 into position over its location on the plan. Use the same technique used with F-10 to hold the fuse sides against the former. Make sure F-9 is perpendicular to the building surface and the embossed number is facing forward.



☐ 28. Glue the die-cut 1/8" plywood **tank tray (TT)** in front of F-9, over its location on the plan.

☐ 29. Glue the unglued portion of former F-8 and the aft end of the crutch to the fuse sides.

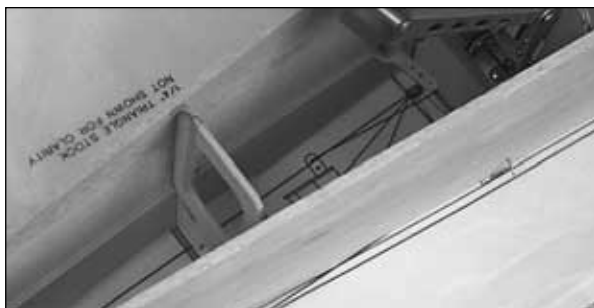

☐ 30. Use medium CA to glue former F-11 into position over its location on the plan. Use the

same technique used with F-10 to hold the fuse sides against the former. Make sure F-11 is perpendicular to the building surface and the embossed number is facing forward.

☐ 31. Carefully sand the outside of the three 36" **outer pushrod guide tubes** with coarse sandpaper so the glue will stick better.

☐ 32. Insert one outer pushrod tube in the holes for the rudder pushrod. Mark and cut out the rudder pushrod exit where the tube contacts the fuse sides.



☐ 33. Approximately 1" of the rudder outer pushrod tube should protrude past the exit hole in the fuse side. Glue the outer pushrod tubes to the formers with medium CA and to the exit slot with a 50/50 mixture of microballoons and epoxy.

☐ 34. After the epoxy has cured, use your bar sander to sand the pushrod guide tube and epoxy filler flush with the fuse side.

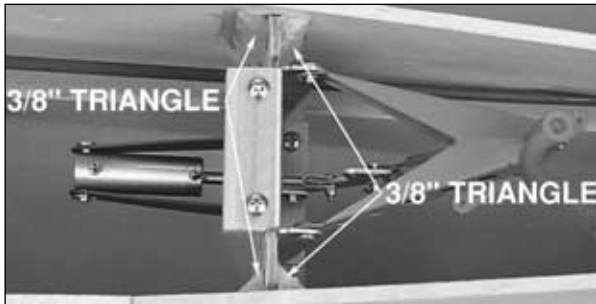

35. Glue 3/8" triangle reinforcement at the forward and aft joints between former F-10 and the balsa fuse sides.

36. Insert the outer pushrod tubes in the holes for the elevator pushrods. Approximately 1" of the guide tube should protrude past former F-11. Insert the pull-pull guide tubes (not included) in the holes for the tail wheel steering. Glue the guide tubes to the formers with medium CA.

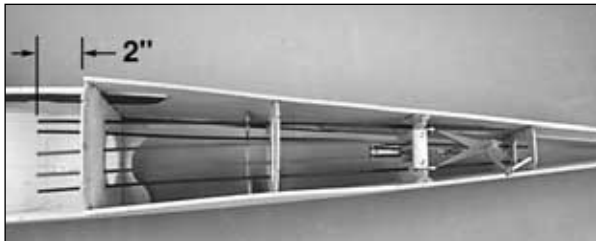

37. Trim the guide tubes 2" in front of former F-8. Save the pieces you cut off.



38. Cut two 14-5/8" lengths from the supplied 3/8" x 30" triangle stock. Glue the triangle sticks along the bottom aft edge of the fuse as shown. Notice on the fuse plan that they stop 5/8" short of the aft end of the fuse sides.

INSTALL THE RADIATOR



1. Test fit the die-cut 1/8" plywood radiator keels into the slots in F-8, F-9 and F-10. You may be required to shorten them slightly. Place a straightedge along the front of former F-8 to make sure it stays straight. as you glue the radiator keels in place.

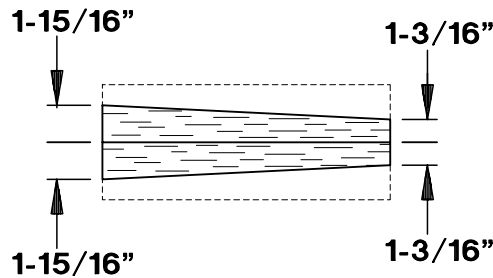

2. Edge glue two 3/16" x 3" x 24" balsa sheets together. Trim the sheet following the drawing to make a radiator bottom. On one side of the radiator bottom, use a razor saw to make multiple cuts about half way through the sheet. This will allow the radiator bottom to bend easier.



3. Wet the radiator bottom with water. Apply CA to the keels, F-8 and F-9. With the cut side down,

pull the sheet into place with multiple pieces of masking tape and allow the wood to dry thoroughly.



4. Use a knife or a razor plane and sanding bar to bevel the radiator bottom and sides. Check the cross-section on the plan for reference.

5. Use the pattern provided on the fuse plan to cut two radiator corners from the two 1/4" x 3" x 24" soft balsa sheets. Place the pattern close to the end of the sheets. **Save** the leftover 1/4" sheeting for use later.



HOW TO USE THE PATTERN TO MAKE THE RADIATOR CORNERS

Cut the pattern from the plan. Spray the back of the pattern with 3M #75 Repositionable Spray Adhesive. Press the pattern onto one of the sheets. Cut the sheet along the lines with a sharp #11 blade.



❑ 6. Glue the radiator corners to the fuse. Wetting these sheets may be required depending on the softness of the wood. You may need to use tape to hold the parts until the glue cures.

NOTE: Remove the fuse from your building surface and reinforce all the difficult-to-reach glue joints from the inside.



❑ 7. Roughly shape the radiator corners with a knife and a razor plane. Save the final shaping until after the aft bottom sheeting has been applied.

INSTALL THE FIREWALL

❑ 1. A pattern for the gauge to set the firewall angle is provided on the fuse plan. The plywood crutch and fuse doublers alone cannot be counted on to set the correct 1.75P of down thrust. Glue the pattern to a piece of plywood or cardboard and cut it out.

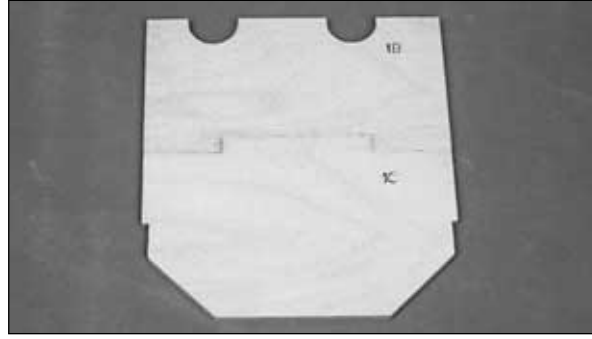

❑ 2. On your flat building surface, glue the die-cut 1/8" plywood **firewall F-1B** to **F-1C**. Sand both sides of the firewall smooth.

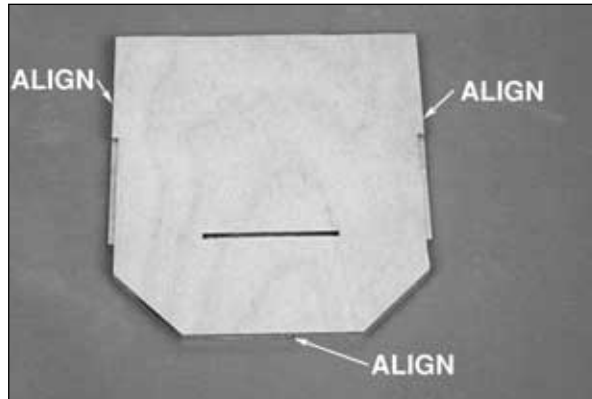

❑ 3. Use 30-minute epoxy to glue the die-cut 1/8" plywood **firewall F-1D** to the back of F-1B/C. Align F-1D with the bottom and sides of F-1B/C. Wipe off any excess epoxy from the notches and tabs. After the epoxy cures, draw a line 2" up from the bottom, on the back of F-1D. (This will be used in step 7 to align the tank floor.)

NOTE: If the firewalls are warped, simply clamping them together may not "cancel out" the warp. It is best to clamp the assembly to a table or a flat board while the epoxy cures.

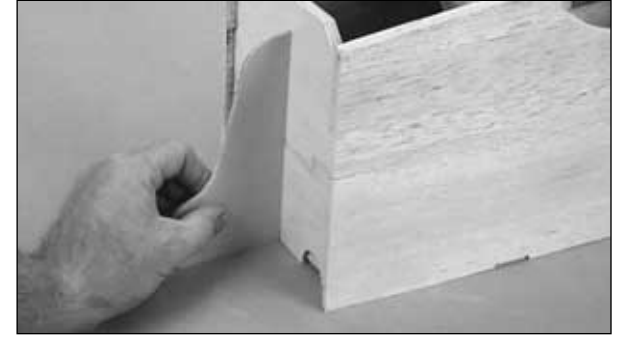

❑ 4. Test fit the firewall assembly into the front of the fuse with F-1B/C facing forward. Check the angle with the firewall gauge. Remember, the crutch and doublers also set right thrust. Make any necessary adjustments.

❑ 5. Use 30-minute epoxy to glue the firewall assembly to the fuse sides and crutch. Use the firewall gauge to check the angle. Wipe off any excess epoxy along the joint between the fuse sides and the firewall.

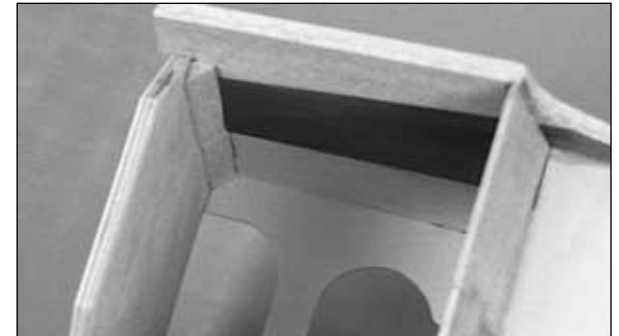

❑ 6. Use 6-minute epoxy to glue 3/8" balsa triangle reinforcements between the back of the firewall and the fuse sides.

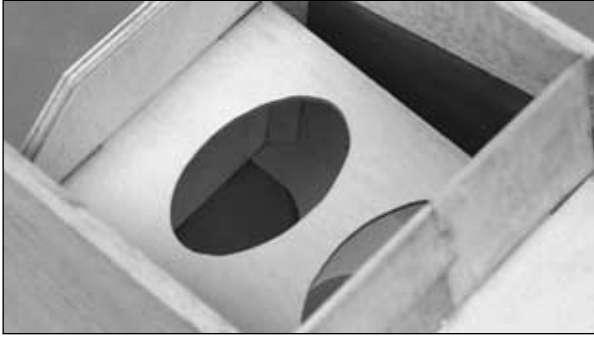

7. Slide the die-cut 1/8" plywood **tank floor** through the notches in former F-3 and align the forward end of the tank floor with the line you drew on the back of the firewall. Use CA to glue the tank floor in position.



8. Cut the 1-1/4" x 15" balsa **triangle stick** in half. Bevel the aft ends of the triangle sticks to match the angle of former F-3. Use medium CA to glue the triangle sticks to the fuselage sides, former F-3 and the firewall.

9. Before the chin blocks are installed, you may want to fuelproof the tank compartment with fuelproof paint or 30-minute epoxy thinned with alcohol.

10. Edge glue the two 1" x 4" x 5-5/8" balsa blocks together to make a 1" x 8" x 5-5/8" **chin block**.

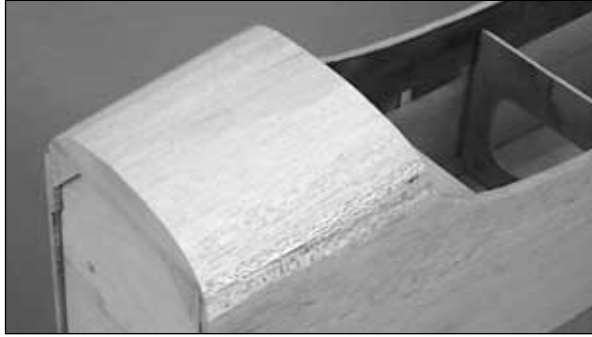

11. Sand the fuselage sides and the 1-1/4" triangle sticks flush with the bottom of former F-3 and the firewall. Use medium CA to glue the chin block to the firewall, former F-3, the fuselage sides and the triangle sticks. Sand the aft edge of the chin block at the same angle and flush with former F-3. Sand the forward edge of the chin block and the triangle sticks flush with the front of the fuselage. Roughly shape the sides of the chin block using the cross-section on the plan as a guide.

MOUNT THE WING TO THE FUSELAGE

1. Use a 3/8" drill bit to clean out the wing dowel holes in formers F-8 and F-8C.

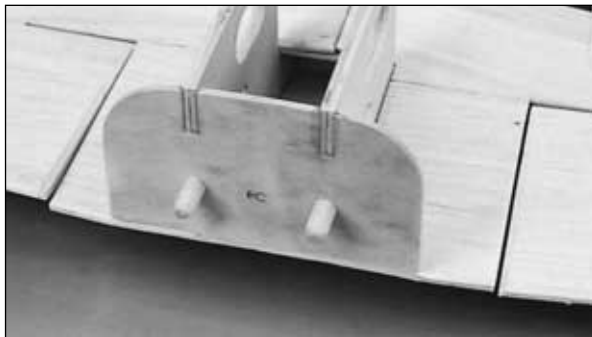

2. Round the ends of the 3/8" x 3-1/2" **wing dowels** and insert the dowels into the wing (do not glue them yet).

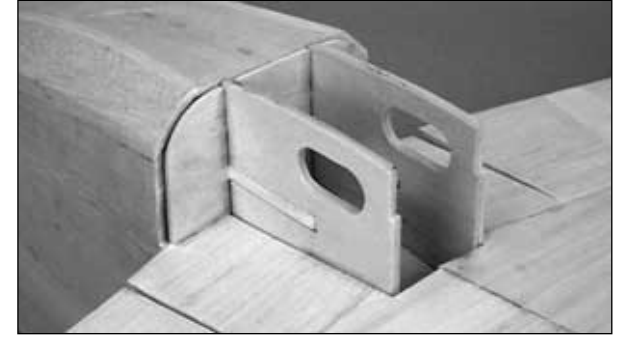

3. Test fit the wing on the fuselage. The fuselage dowel holes may have to be enlarged slightly to allow the wing to fit smoothly.

4. Adjust the parts until the wing fits well on the saddle. The CLE (center LE) and the wing saddle may require slight adjustments.

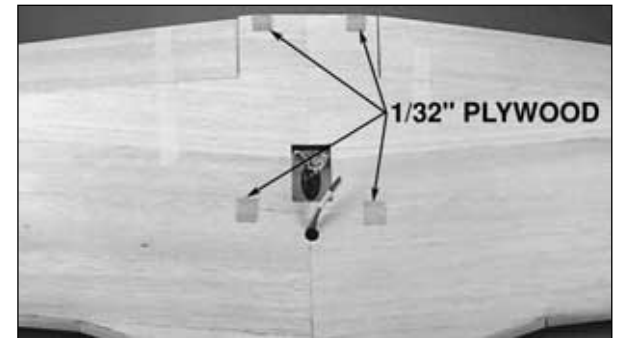

5. Tape some leftover 1/32" plywood (from the wing fillet base die-cut sheet) to the wing skin near the trailing edge and over the spar to simulate the die-cut 1/32" plywood **fillet base** being in place. Again test fit the wing to the fuselage. If there is much interference preventing the wing from seating on the wing saddle, shape the wing dowel holes oblong until the interference is gone.

6. Draw a centerline on the CLE to use as a reference when aligning the wing.



7. Tape a piece of leftover balsa between the fuse sides at the aft end of the fuse. Insert a T-pin in the leftover balsa on the fuse centerline and tie a string to the pin, which will help with wing alignment.

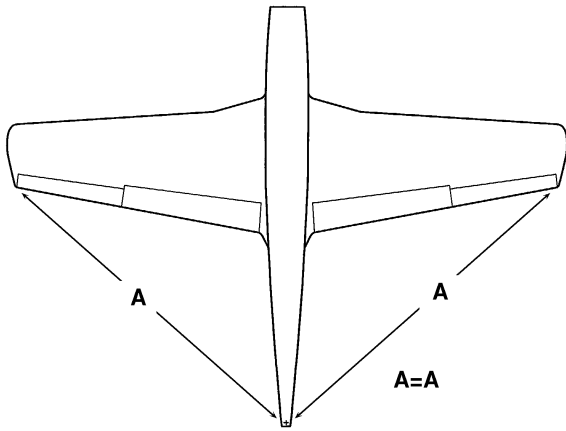

8. Place the wing in position on the fuse. Pull the string (with one end attached to the pin at the tail) out to a wing tip. Put a piece of tape on the string to mark the intersection of the string and the wing tip. Swing the string over to the other wing tip and check to see if the distances are the same. Adjust the position of the LE of the wing until the wing is properly aligned.

NOTE: Make sure the wing is held securely and cannot shift while you are drilling the mounting holes.



9. Drill through the two holes in the wing bolt plate and through the fuse bolt plate with a 13/64" drill bit (or #10 drill bit). Remove the wing and tap the holes in the **fuselage bolt plate** with a 1/4-20 tap. Wick thin CA into the threads to harden them. Allow the CA to cure. Screw the tap back through the hole again to clean up the threads. Drill the holes in the **wing bolt plate** only with a 17/64" drill bit.

10. Remove the wing dowels from the wing. Apply 30-minute epoxy in the slots for the wing dowels. Insert the wing dowels back into the slots. Wipe off any excess epoxy on the back of F-8C to prevent gluing the wing to the fuse. Bolt the wing back on the fuse. Check to be sure the dowels at the TE of the wing are centered in the slots. Allow the epoxy to cure before moving the wing.

ATTACH THE STAB AND FIN

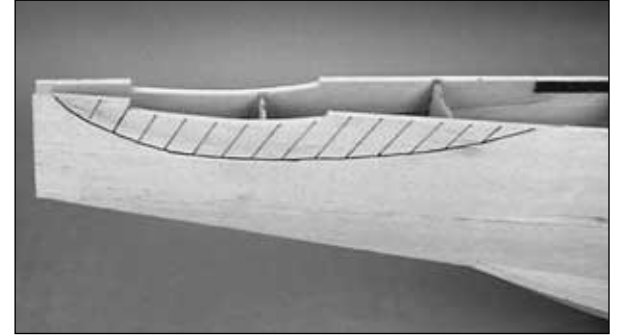

1. For scale accuracy, the fuse sides in the area of the stab saddle need to be contoured. Study the cross sections at formers F-10 and F-11 on the plan as well as the photo. Use a razor plane and sanding bar to obtain the proper shape.

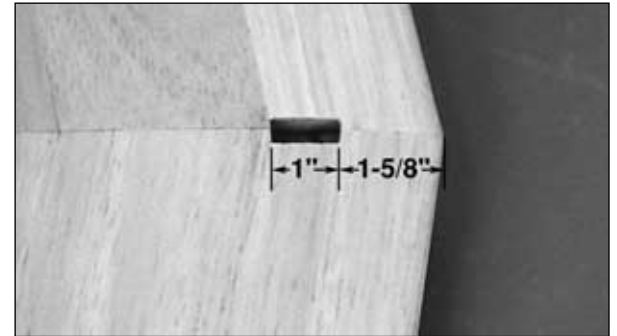

2. Mark one side of the stab to be the top (the stab is symmetrical so it doesn't matter which is the top). Make a mark 1-5/8" behind the LE at the center of the stab. Make another mark 1" behind that one.

3. Cut a slot in the stab skin between the two S-1 stab ribs and between the marks. Cut the same slot in the bottom skin.

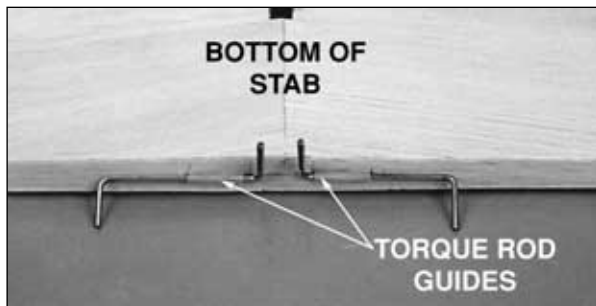

❑ 4. Use the stab plan to locate the elevator torque rod positions. Cut slots centered in the stab TE for the torque rod guides. Test fit the elevator torque rods in the TE of the stab.

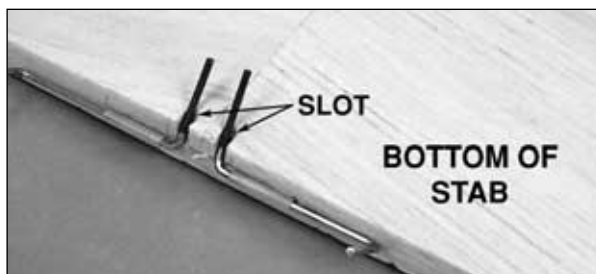

❑ 5. Cut slots in the stab TE to allow the torque rods to pivot freely.

❑ 6. Make sure the fin LE will fit through the slot in the stab.

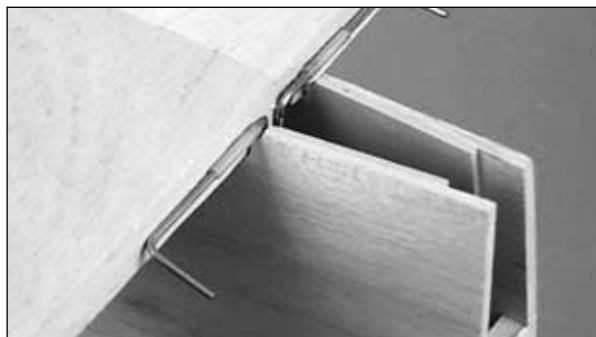

❑ 7. Cut a notch at the aft edge of the stab saddle to give the elevator torque rod room to rotate. Test fit the stab onto the stab saddle. Make small adjustments to the saddle if necessary for a good fit.

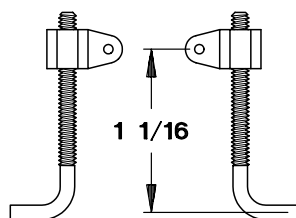

❑ 8. Thread a **nylon torque rod horn** onto each elevator torque rod so that the center of the torque rod horn is 1-1/16" from the center of the bend. It's important that both horns are the same distance from the center of the bend.

❑ 9. Slide the torque rod guides to their proper locations on the torque rods. Apply a small amount of petroleum jelly to the torque rods where they enter the guides to prevent the glue from getting inside and "locking up" the guides. Use 6-minute epoxy to glue the elevator torque rod guides in the stab TE.

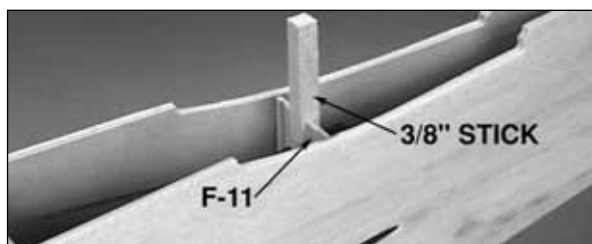

❑ 10. Stick a short piece of 3/8" balsa into the slot in former F-11 to simulate the fin LE. Bolt the wing onto the fuse for reference.

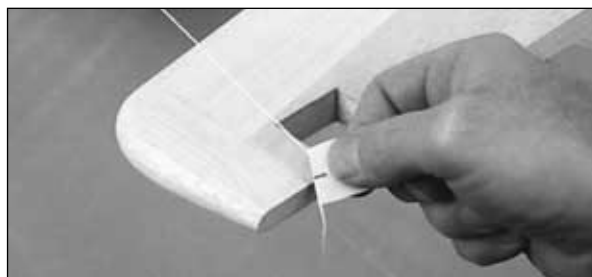

❑ 11. Position the stab in the stab saddle. Check the alignment of the stab with the wing from the

front and rear of the model. If the stab tips are not equidistant above the wing, carefully sand the high side of the stab saddle until the stab and wing are parallel. Using the "pin and string" technique, with the pin centered on the top edge of the firewall, align the stab with the fuse.

❑ 12. Use 30-minute epoxy to glue the stab to the stab saddle and former F-11. Recheck the stab position before the epoxy cures. Remove the 3/8" balsa stick from former F-11.

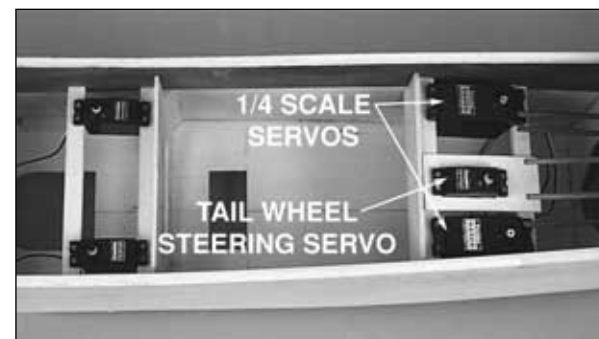

❑ 13. From 1/4" x 1/2" x 32" hardwood, cut **servo rails** to fit between the fuse sides in the notches in the fuse doubler. Use a couple of servos to check the spacing of the rails.

NOTE: If you are using 1/4-scale servos on the elevator and rudder the servo rail spacing will be wider and a separate servo tray is provided for the tail wheel steering servo.

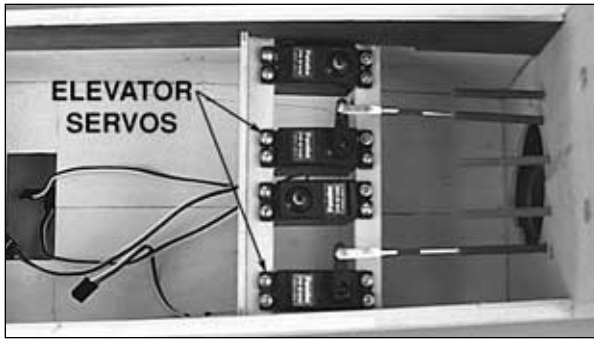

❑ 14. Install the two elevator servos, rudder servo and tail wheel steering servo in the fuse. Hook up the radio and center the servo arms on the elevator servos. Thread **4-40 metal clevises** onto two **4-40 x 36" threaded pushrods**. Insert the pushrods into the elevator outer pushrod tubes and connect the clevises to the servo arms on the elevator servos.

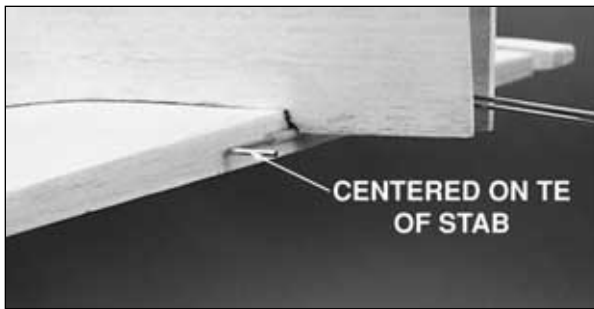

❑ 15. Attach metal solder clevises to the torque rod horns. Center the servo arms on the elevator servos and move the torque rods to the neutral position.

❑ 16. Mark the elevator pushrods at the clevis. Remove and cut the elevator pushrods to the appropriate length.



❑ 17. Use silver solder to solder the solder clevises onto the ends of the elevator pushrods.



How To Achieve A Good Solder Joint

A. Roughen the area to be soldered with fine sandpaper. Thoroughly clean the area with rubbing alcohol.

B. Assemble the items to be soldered.

C. Apply a small drop of solder flux to the joint.

D. Heat the area to be soldered. Apply solder to the heated area. The metal must get hot enough to melt the solder and the solder must flow into the joint. Do not melt the solder by touching it to the soldering iron.

E. Do not move the parts until the solder has cooled.

F. Clean off the excess flux with alcohol.

G. Test the joint by pulling on it.

❑ 18. Remove the 4-40 threaded metal clevises and slide a **silicone retainer** over the solder clevises. Insert the elevator pushrods into the elevator outer pushrod tubes from the aft end of the fuse. Attach the metal clevises to the torque rods and slide the silicone retainers over the clevises.

❑ 19. Thread a 4-40 nut onto each of the elevator pushrods. Slide a second silicone retainer onto both elevator pushrods and thread the 4-40 metal clevises back on. Attach the clevises to the elevator servo arms to confirm that the elevator pushrods are the proper length and operate without binding. Once the fin is glued on the stab, the elevator pushrods will be very difficult to remove.



❑ 20. Work the fin into position on the stab. Trim any fin sheeting that prevents the fin TE from standing vertical when viewed from the side. Refer to the fuse side view on the plan.

❑ 21. Check the fin from the front and rear of the model to make sure it is perpendicular to the stab. Use 30-minute epoxy to glue the fin to the forward top sheeting of the stab, F-11 and the aft fuse sides. Before the epoxy cures, recheck the fin for alignment.

BUILD THE ELEVATORS

❑ ❑ 1. From four 3/32" x 3" x 24" balsa sheets make four **elevator skins**. Use the elevator skin template on the wing plan as a guide. Save the excess sheeting to make the elevator end caps.

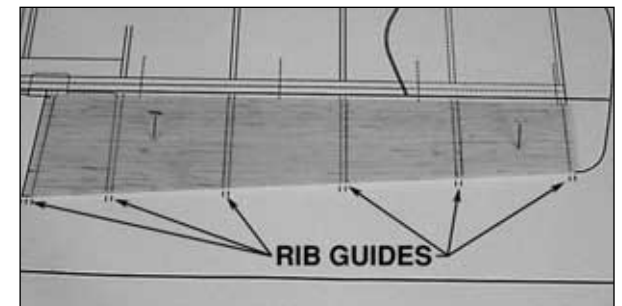

❑ ❑ 2. Pin one of the elevator skins to your building surface. Use the rib guides on the plan to mark the rib locations on the bottom skin.

NOTE: The elevator skin goes from the outside of

rib **E-1** to the outside of rib **E-6**. After the top and bottom skins are applied, a 3/32" balsa cap will be installed on the face of E-1.

☐☐ 3. Place the die-cut 1/8" balsa **elevator sub LE** on the forward edge of the bottom skin. The wider end of the sub LE goes on the wider end of the elevator skin. **Do not** glue it yet!

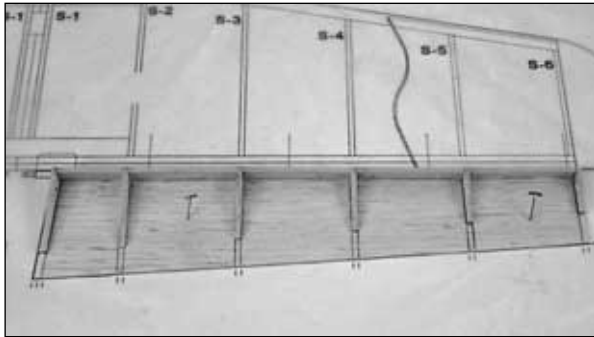

☐☐ 4. Insert the die-cut 1/8" balsa **elevator ribs** in the notches of the elevator sub LE. Position the ribs on the bottom skin aligned with the guides. The forward edge of the sub LE should be flush with the forward edge of the bottom skin. Use thin CA to glue the assembly together.

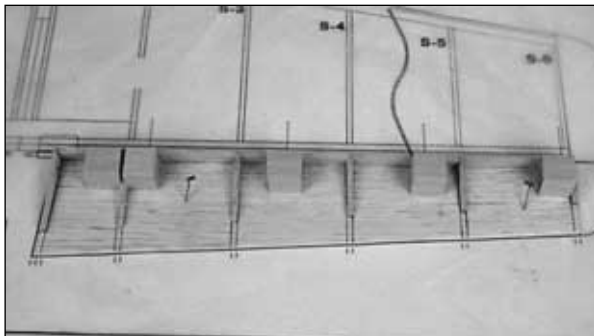

☐☐ 5. Cut five 3/4" long pieces from the 3/4" x 3/4" x 30" balsa stick to make hinge point backups. Glue the backups at the locations shown on the elevator plan.

☐☐ 6. Use a razor plane and sanding bar to blend the sub LE and hinge point backups flush with the upward facing edge of the ribs. Sand the TE of the elevator skin to the same angle as the ribs.

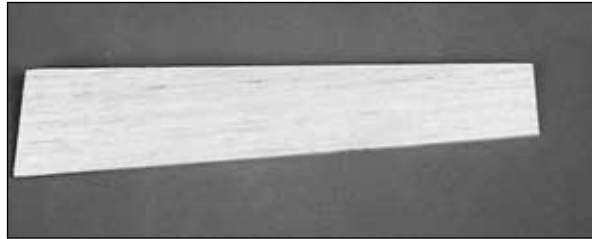

☐☐ 7. Glue a second balsa elevator skin to the top of the elevator sub LE, ribs, hinge point backups and bottom elevator skin.



☐☐ 8. Cut the 1/4" x 3/4" x 30" balsa stick in half to make two **elevator LE's**. Glue the elevator LE to the front of the sub LE.

☐☐ 9. Sand the LE flush with the top and bottom elevator skins. Trim and sand the end of the elevator skins and LE flush with the outside face of ribs E-1 and E-6.



☐☐ 10. Glue a piece of leftover 3/32" balsa to the face of the E-1 rib.



☐☐ 11. Glue the shaped 5/8" balsa **elevator tip** on the face of the E-6 rib. Use a razor plane and sanding bar to sand the elevator tip flush with the top and bottom elevator skins.

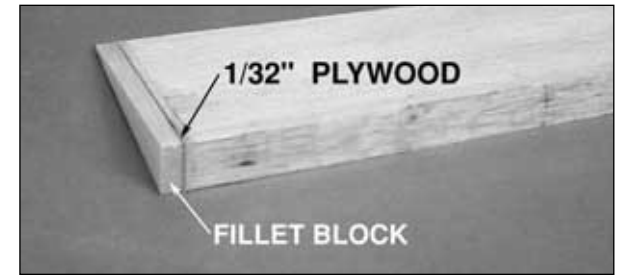

☐☐ 12. **Tack glue** a piece of leftover 1/32" plywood and a piece of 1/4" balsa to the root end of the elevator to make a **fillet block**. The 1/32" piece of plywood is used as a spacer. Sand the block so that it is flush with the LE, TE and elevator skins.



☐☐ 13. Hold the elevator against the TE of the stab with the fillet block against the fuse side. Sand the fillet block so that it fits flush with the fuse sides. Mark the location where the elevator torque rod will be inserted into the elevator.



14. Drill a 3/32" hole into the elevator for the torque rod, perpendicular to the LE. Make a slot large enough to clear the torque rod from the 3/32" hole to the root end of the fillet block.

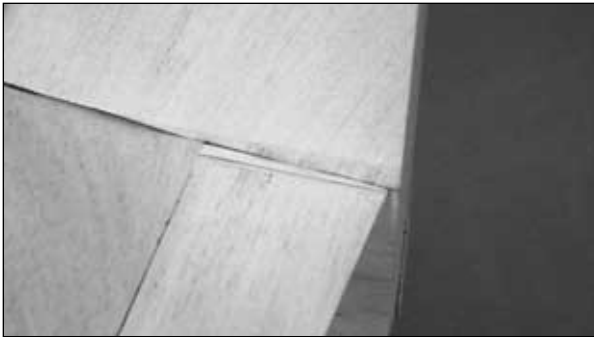

15. Reinstall the elevator and fillet block. Glue the fillet block to the fuse. Remove the elevator and 1/32" plywood spacer from the fillet block.

16. If you want to modify the elevator for the scale balance tab, now is the time to add the appropriate structure. We made our balance tab from leftover 3/32" balsa sheeting and 1/8" balsa from the die sheets.

17. Go back to step 2 and construct the other elevator.

NOTE: Make sure to construct it over the other elevator plan.

ENGINE INSTALLATION

FUSELAGE COMPLETION

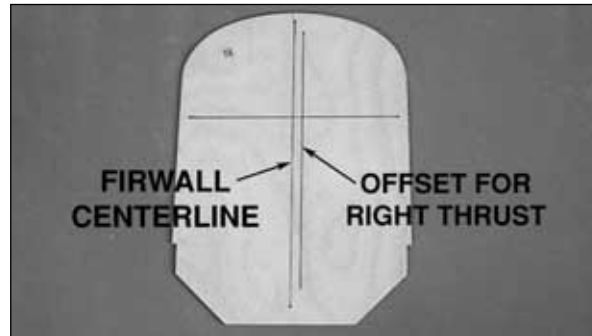

1. The firewall F-1A has punch marks to locate the centerline of the engine. Notice that the punch marks for the vertical line are offset to allow for the right thrust of the engine.

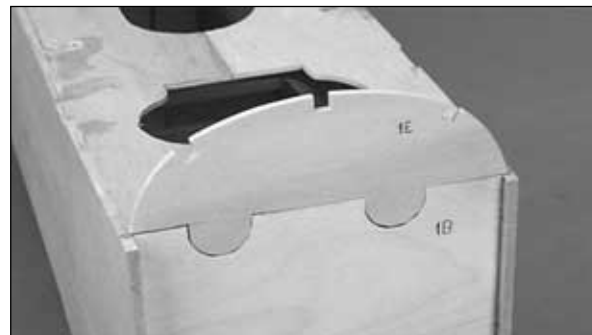

2. Glue the die-cut 1/8" plywood **former F-1E** into the notches in F-1B. Lay a straightedge along the face of F-1B/C to make sure F-1E is flush with F-1B/C.



3. Use 30-minute epoxy to glue the firewall F-1A to F-B/C/E on the front of the fuse.

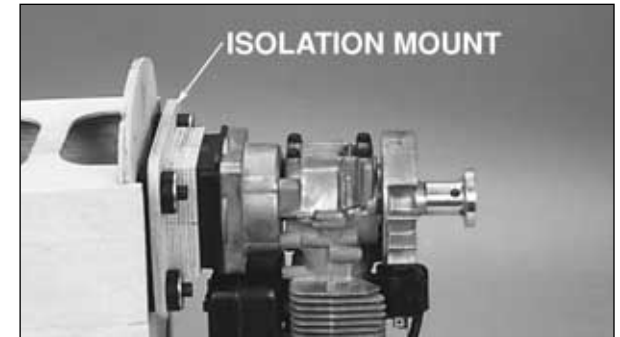

4. Mount the engine using the instructions that came with your engine mount. We strongly recommend that any engine used on the Giant P-51D be installed on an isolated engine mount. The use of this type of engine mount will help prevent damage to the radio system and the airframe due to engine vibration. **The back of the spinner should be spaced 7-7/8" from the firewall no matter what mounting method is used.** Spacers made from 1/4" plywood work well for spacing the engine away from the firewall. Center the engine mount on the horizontal centerline and the offset vertical line.

5. Place the throttle servo on the forward servo rails. Make a mark on the firewall in line with the throttle arm for the throttle pushrod exit. Remove the engine and drill a 3/16" hole at the mark. Insert

a leftover piece of outer pushrod tube. Drill a 3/16" hole through former F-3 so that the outer pushrod tube is aligned with the throttle servo arm. Glue the outer pushrod tube to the firewall and F-3.

❑ 6. On our prototypes we mounted the air retract fill valves to the firewall below the engine. Now is a good time to drill a hole for the air line to pass through the firewall.

❑ 7. Fit a piece of foam rubber on the tank floor. Assemble the fuel tank per the manufacturer's instructions. Slide the fuel tank into the fuel tank compartment and check its fit. You may want to glue braces made from leftover balsa in the tank compartment to prevent the tank from moving around. Remember to use foam rubber around the tank to prevent the fuel from foaming due to vibration.

❑ 8. Drill two 1/4" holes in the firewall, one for the fuel line to the carburetor and the other for the overflow line, on gas engines, or pressure line on glow fuel engines.

❑ 9. Remove the engine and fuel tank.



❑ 10. Glue the die-cut 1/8" plywood former tops **F-8E**, **F-9B** and **F-10B** to the tops of their respective formers.

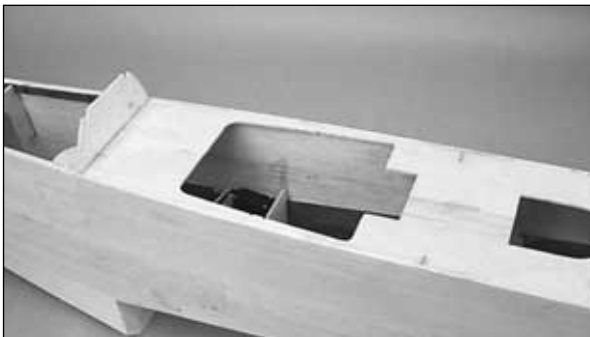

❑ 11. Finish cutting out the cockpit if you will be installing the optional cockpit kit. If not, glue along the partially die-cut cockpit floor to reinforce it.

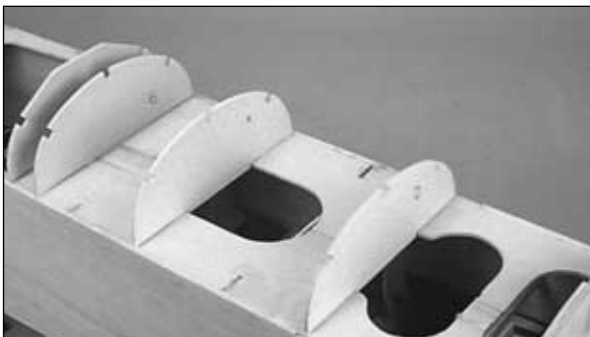

❑ 12. Glue in the die-cut 1/8" plywood formers **F-2**, **F-4**, **F-6** and the **instrument panel (IP)** perpendicular to the crutch.



❑ 13. Install the 1/4" square balsa **stringers** into the slots from the firewall to former IP and from F-8E to the LE of the stab.

NOTE: If you prefer to run your receiver antenna through the fuse, now is a good time to install an outer pushrod tube (not included) in the fuse. Make sure the tube does not interfere with the operation of the tail wheel retract and elevator torque rods.

❑ 14. From the four 1/8" x 3" x 24" balsa sheets, glue two of them together to make forward deck sheets 1/8" x 6" x 24". Use the pattern on the fuse plan as a guide to cut two forward deck sheets. Save the leftover sheeting cut from the pattern.



☐ ☐ 15. Thoroughly wet the **outside** of the forward deck sheeting with warm water. Allow the water to soak into the wood for a few minutes. Test fit the sheet to the stringers and formers. The deck sheeting between formers IP and F-6 should go to the middle of the side stringer and the center of former F-6. Glue the forward deck sheet along the top edge of the fuse sides.

☐ ☐ 16. Apply glue to the formers and stringers. Bend the wood around and attach it to formers F-2 and F-4 first. Hold the deck so it conforms to former F-6. Apply some additional thin CA to the joint.

☐ ☐ 17. Holding the deck so it conforms with F-1, apply CA to the joint. Trim the sheeting along the **centerline** of the top stringer.



☐ 18. Repeat steps 15 through 17 for the other side of the fuse.



☐ 19. Fit leftover 1/8" forward deck sheeting from F-6 to behind the IP.

☐ 20. Cut the two **aft deck sides** out of two 1/8" x 3" x 36" balsa sheets. Use the pattern on the fuse plan as a guide. Sand a slight angle on the bottom of the deck side at the aft end. This will allow the aft end of the deck side to be installed at a slight angle (see the next step).



☐ 21. Glue the aft deck sides to the top of the fuse sides. Wet the deck sides before bending and gluing them to the formers and stringers.



☐ 22. True the top of the aft deck sheeting and 1/4" stringers with a razor plane and a bar sander.

☐ 23. Trace the shape of the top of the fuse deck onto the 5/8" x 4" x 24" balsa **aft deck block**. Rough cut the block to shape, carving the aft edge of the block so it will fit over the stab.



☐ 24. Glue the aft deck block to the stab, aft deck sides and the formers. Shape the block as shown in the fuselage cross-sections.

INSTALL THE DORSAL FIN

NOTE: A few early P-51Ds did not have a dorsal fin. If you have a particular plane/trim scheme in mind, check to see if it has a dorsal fin.

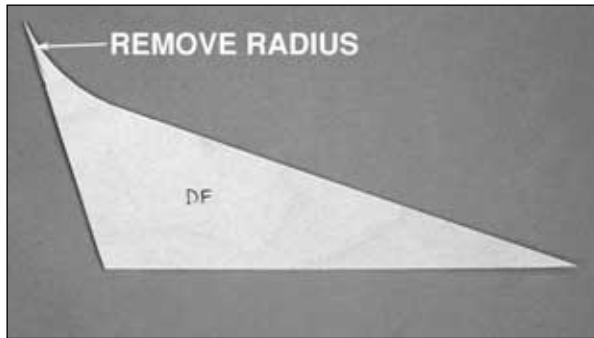

1. Because of the limitations of die-cutting, finish cutting the die-cut 1/16" plywood **dorsal fin (DF)** as shown.

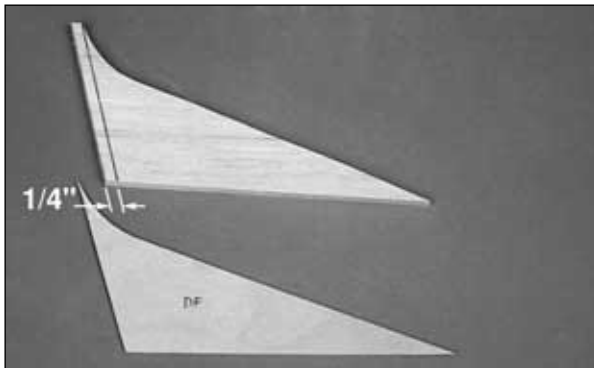

2. Cut a 3/8" x 3" x 24" balsa sheet in half and edge glue the two pieces together. Trace the die-cut 1/16" plywood dorsal fin (DF) twice onto on to the 3/8" x 6" x 12" sheet. Draw a line 1/4" back from the aft edge of the ply dorsal fin and cut out the parts. Save the leftover balsa sheet for use on the cowl.

3. Draw a centerline on the aft deck to aid in centering the dorsal fin.

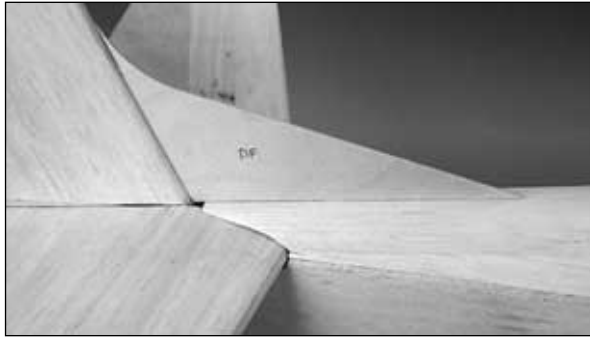

4. Glue the 1/16" plywood dorsal fin (DF) to the fin and aft deck. It must line up exactly with the fin and fuselage centerline.



5. Fit the balsa dorsal fin side pieces to the plywood dorsal fin. Start by shaping the aft edge of the side pieces so they overlap the fin slightly. Fit and shape the side pieces as well as you can before gluing them on. The LE needs to be sanded to 3/8" wide to match the fin. Glue the side pieces to both sides of the plywood dorsal fin.

6. Fill the area just behind the dorsal fin with leftover balsa and filler to obtain a smooth transition.

MAKE THE TOP COWL

1. Sand the fuselage sides, forward deck and chin block flush with the firewall and reinstall your engine.

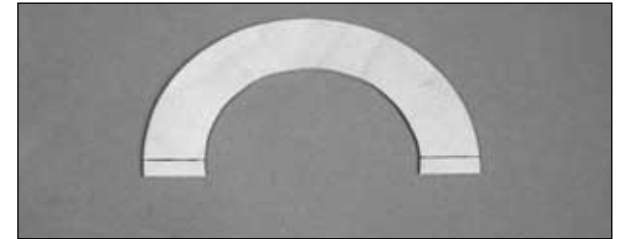

2. Draw a line 1/4" above the bottom edge of the die-cut 1/16" plywood **spinner ring**. Use these lines to center the spinner ring on the back of the spinner.

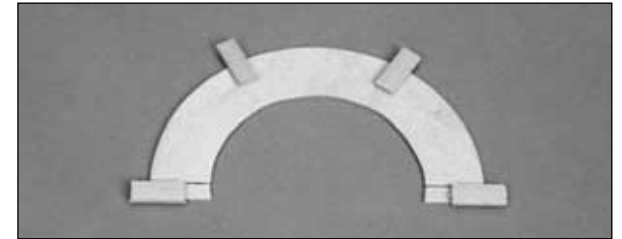

3. Glue leftover 1/16" (or 3/32" for soft mounted engines) balsa to the spinner ring to act as a spacer between the spinner and plywood spinner ring.

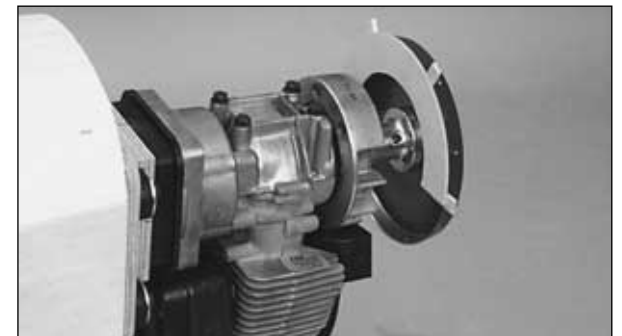

4. Tack glue the spacers on the spinner ring to the backplate of the spinner. Make sure the spinner ring is centered on the backplate. Mount the spinner backplate to the engine.

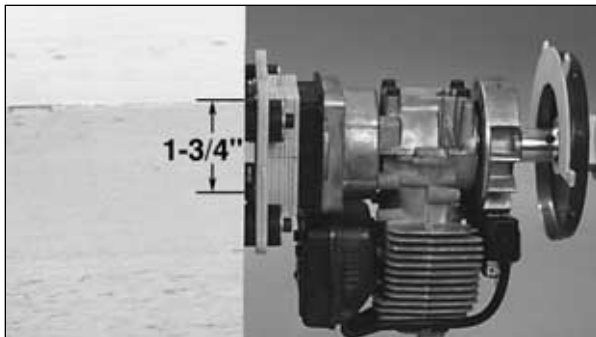

❑ 5. Make a mark on the outside of the fuselage sides 1-3/4" below the fuse side's top edge. This mark will designate the bottom of the cowl sides.



❑ 6. Trim the 1/2" x 2-7/8" x 8-1/8" balsa **cowl sides** to they fit between the fuse sides and the spinner ring. The bottom edge of the cowl sides should align with the bottom edge of the spinner ring and the mark you made on the fuse sides. Notice on the top view of the fuse plan how the cowl sides protrude outward from the fuse and spinner ring about 1/8" to allow for shaping.

❑ 7. **Tack glue** both of the cowl sides in place. View the cowl sides and the spinner ring from the front to make sure they are on straight and not touching the engine or engine mount. Securely glue the parts in place.



❑ 8. Fit the 3/4" x 3-5/8" x 8-1/8" balsa **cowl top** in position and glue it in place.



❑ 9. Carefully cut the corners at an angle with a sharp knife as shown in the photos. Use a bar sander and coarse sandpaper to finish making a flat area for the cowl corners to fit.



❑ 10. The **cowl corners** are made from the remaining 3/8" x 3" x 24" balsa used for the dorsal fin. Fit the cowl corners between the spinner ring and firewall. Once the cowl corners fit properly, glue them in place.



❑ 11. Use a razor plane and a bar sander to shape the nose. Apply masking tape to the spinner to prevent scratching it while blending the nose into the spinner.

ASSEMBLE THE COWL



❑ 1. Trim the left and right cowl halves along the molded cut lines. Note that the right cowl half has a tab along the joint that the left cowl half fits over. You can use a hobby knife to **carefully** score along the cut lines and flex the plastic until it breaks free, or use small scissors to cut along the lines. Hobbico® Curved Tip Canopy Scissors (HCAR0776) work extremely well for this.

❑ 2. Use your bar sander to carefully true the edge of the overlap so when you glue them together the seam will be as small and straight as possible. **Thoroughly** roughen with 80-grit sandpaper, all areas that are to be glued. Also, roughen the area inside the cowl at the front joint.

❑ 3. Test fit the cowl halves together and make adjustments as necessary.

❑ 4. Join the cowl halves together with thin or medium CA.

NOTE: Do **not** use CA accelerator. Use of accelerator on the ABS plastic may cause cracks and/or prevent paint from adhering.



❑ 5. Remove the engine from the fuse and test fit the cowl in place. Trim the cowl until it fits as shown on the plan sheet. Mark the outline of the cowl on the fuselage.

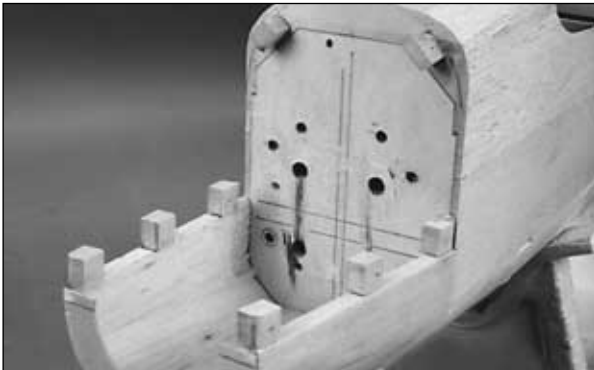

❑ 6. Refer to the fuse plan and the photo above for the location of the 1/2" x 3/4" x 3/4" hardwood **cowl mounting blocks**. Use epoxy to glue the blocks at the proper locations. Make sure to offset the blocks to allow for the thickness of the plastic cowl. The two cowl blocks mounted on the firewall will need to be rounded slightly to match the curvature of the bottom of the cowl.

❑ 7. Mark the location of the mounting blocks on the fuse. Tape the cowl securely to the fuse and drill 3/32" holes through the cowl and mounting blocks. Remove the cowl and enlarge the holes in the **cowl only** with a 1/8" drill bit. Attach the cowl to the fuse using #4 x 1/2" button head screws.



❑ 8. Reinstall the engine on the firewall. Use pieces of thin cardboard or plastic to make templates for the head of the engine, carburetor and exhaust.

❑ 9. Remove the engine from the fuselage without disturbing the templates. Reinstall the cowl and transfer the hole locations from the template onto the cowl.



❑ 10. Remove the cowl and templates and reinstall the engine. Cut the openings in the cowl slightly undersize and test fit it on the fuse. Make adjustments as needed. Also cut a cooling exit hole in the aft bottom of the cowl and a cooling entrance hole in the front of the cowl.

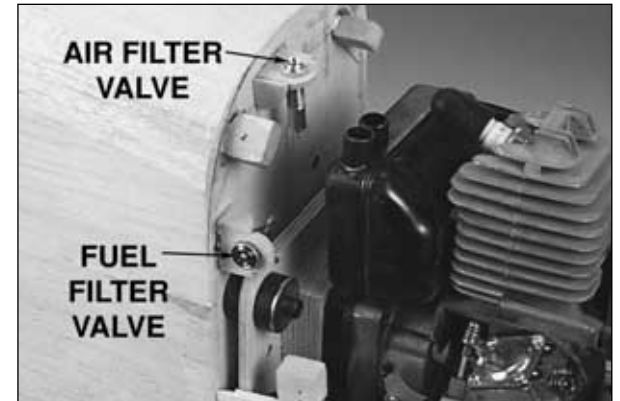
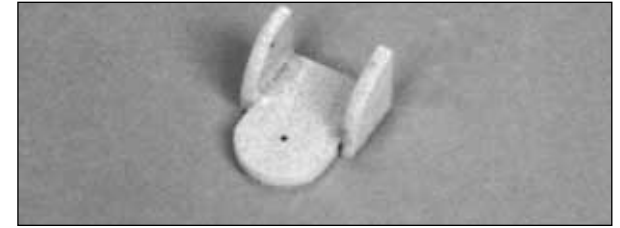

❑ 11. Supplied in the kit are four die-cut 1/8" plywood valve mounts. These mounts can be used for mounting the air filler valve, fuel filler valve or kill switch if installing a gasoline powered engine. Glue the sides to the mount and attach them the firewall. We mounted the air filler valve and kill switch at the bottom of the cowl and the fuel filler valve on the side of the cowl behind the carburetor. Cut the appropriate openings in the cowl for these accessories.

❑ 12. Glue fiberglass around the mounting holes and along the seams on the inside of the cowl. For maximum protection against stress cracking, you may apply 3/4oz. fiberglass cloth to the entire inside surface of the cowl. Adhere the cloth with thin CA.

❑ 13. Before painting the cowl, fill the seams and other imperfections with filler such as Squadron White Putty, or resin filler such as Bondo®. We use Bondo most of the time because it cures quickly and is easy to sand. Squadron putty works well, but it takes several hours to cure.

14. After the filler cures, sand it flush with the plastic. Wet sand the entire cowl with 400-grit sand paper in preparation for primer.

BUILD THE WING FILLETS

NOTE: There are many techniques to build a wing fillet. Some modelers prefer to carve the entire fillet from balsa. Others use a mixture of epoxy and micro balloons to finish the fillet. If you have a favorite technique, feel free to use it. The technique described below works fine for aircraft covered with MonoKote film.

1. Remove the die-cut 1/32" plywood **wing fillet bases** from their die blanks. Cut the "die-cut bumps" off the aft end of the parts with a straightedge and hobby knife.

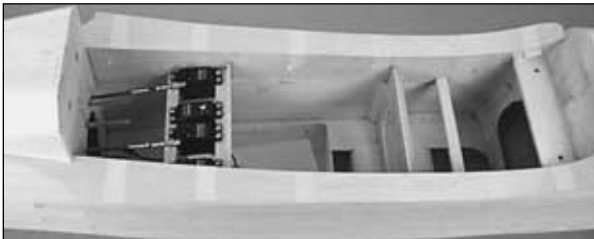

2. Tape the wing fillet bases to the wing saddle as shown. Notice how the wing fillet bases overlap the wing saddle and fit around the fuse behind the wing saddle.



3. Tape a layer of wax paper or Plan Protector to the top surface of the wing in the wing saddle

area (the shims used to simulate the thickness of the fillet bases in earlier steps should be removed). Bolt the wing firmly onto the fuselage. Check to make sure the wing fits properly along the wing saddle, making adjustments as needed.



4. With the wing bolted to the fuse, glue the wing fillet bases to the wing saddle.

NOTE: The wing fillet may be built up with small balsa blocks and triangle stock, or you may use the technique described below.



5. From the 1/16" balsa sheet cut a tapered fillet sheet to fit between the fillet base and the fuse side. Test fit it against the wing saddle and trim to fit. A little concave curvature on the side that contacts the wing fillet base helps. You may need to make a few braces to fit under the fillet sheet especially toward the aft end of the fillet.



6. Glue the balsa fillet sheet in place starting in the middle and working toward each end. The angle of the fillet should be approximately 45° from the middle forward and flatten out toward the aft end.

7. Apply HobbyLite filler to the fillet. Trowel it on with a spatula. Wet your fingers with water and use them to contour the filler.



8. Turn the plane over and build the small fillet on the bottom side of the fillet base behind the wing.

❑ 9. Allow the filler to dry completely. It may take overnight, depending on the thickness of the filler.

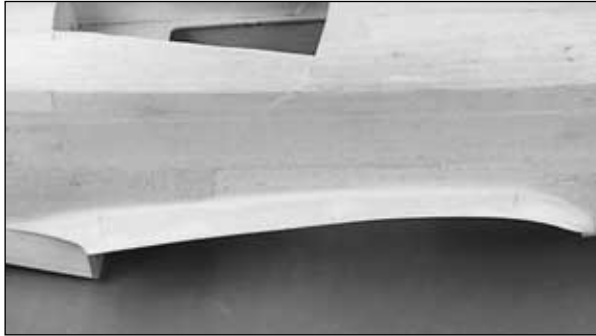

❑ 10. Use cylindrical sanding tools to final shape the fillet. Remove the wing and clean up the edges of the fillet. Wick thin CA into the joint of the fillet base and the wing saddle from inside the fuse.

INSTALL THE FORWARD WING FAIRING

❑ 1. Install the wing onto the fuse with wax paper or Plan Protector under the front portion of the wing saddle.

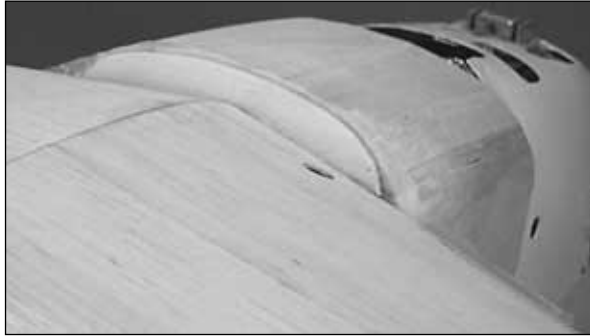

❑ 2. Check the fit of the die-cut 1/8" plywood F-3C. Trim the height of F-3C until it is undersized compared to the chin block height by 3/32". This will leave room for sheeting.

❑ 3. Glue F-3C to the wing with medium CA.



❑ 4. Cut the 3/32" balsa sheeting for the fairing using the pattern on the fuse plan. Test fit and trim the sheet until it fits well. For best results, sand the sheet thinner toward its aft end.

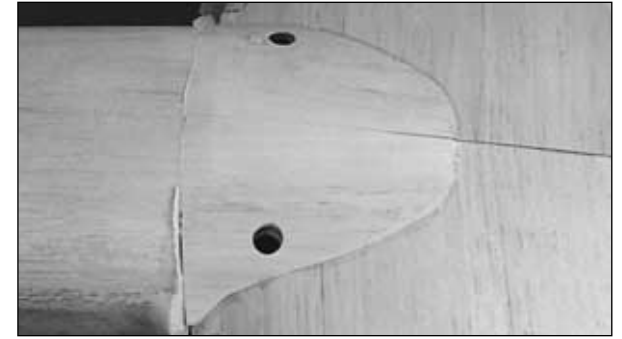

❑ 5. Glue the fairing in place. Blend the fairing into the chin block. Use balsa filler to blend the fairing into the wing.

❑ 6. With the bottom cowl installed, use a razor plane and sanding bar to blend the chin block to the cowl.

FIT THE SCOOP

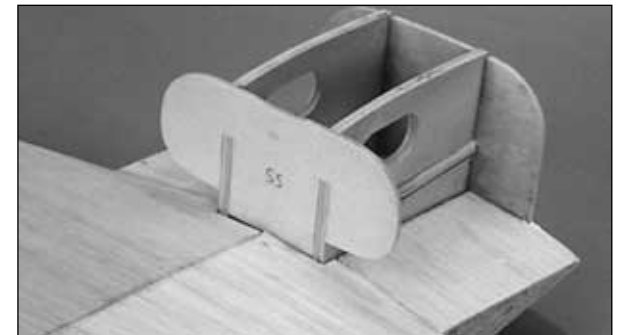

❑ 1. Place the die-cut plywood **scoop support (SS)** in position on the bottom of the wing, but do not glue it yet.

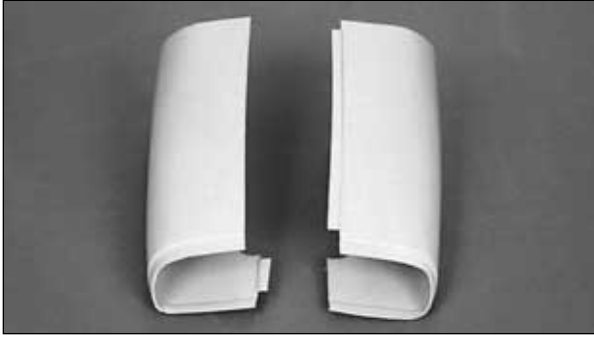

❑ 2. Trim the **left** and **right scoop** halves along the molded cut lines. Notice that the left scoop half has a tab along the joint that the right scoop half fits over.

❑ 3. Use your bar sander to carefully true the edge of the overlap so when you glue them together the seam will be as small and straight as possible. **Thoroughly** roughen all areas that are to be glued. Also, roughen the area inside the scoop along the joint.

❑ 4. Test fit the radiator halves together and make adjustments as necessary.

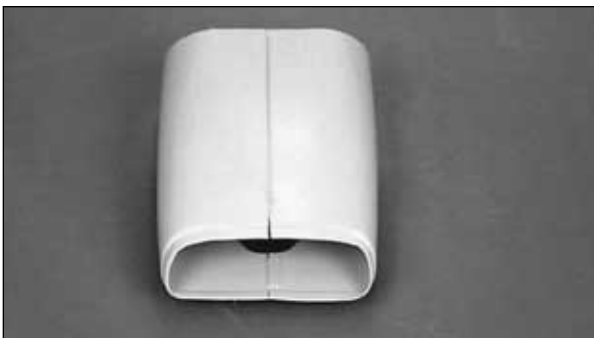

❑ 5. Join the scoop halves together with thin CA.



❑ 6. Trim out the **scoop front**. Fit and glue it to the scoop sides.

❑ 7. Slide the radiator scoop over the support and into position. It should slide on far enough to overlap F-8C about 1/32". Check for binding or resistance. Trim or sand the formers or scoop if required for a good fit.

❑ 8. Glue the plywood scoop support to the wing.

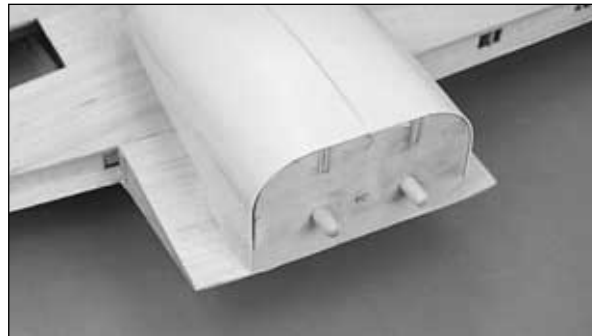

❑ 9. Mark the aft edge of the scoop along the edge of F-8C. Trim the scoop flush with the aft surface of F-8C.

❑ 10. Mount the wing to the fuse. Test fit the scoop and check its fit with regard to the fuse and wing. Make slight adjustments if necessary.

❑ 11. Apply fiberglass around the inside of the scoop along the seams.

❑ 12. Before painting the scoop, fill the seams and other imperfections with filler.

❑ 13. After the filler has cured, sand it flush with the plastic. Wet sand the entire cowl with 400-grit sandpaper in preparation for primer.

NOTE: You may glue the scoop on now with CA or epoxy, fillet it in and finish it with the rest of the airplane. However, the easiest thing to do, as done on our prototypes, is to paint the scoop separately and glue it on after the rest of the model is finished. This technique does not give you an upper fillet (between the scoop and the wing), but an upper fillet is not important for sport flying.

HINGING THE CONTROL SURFACES

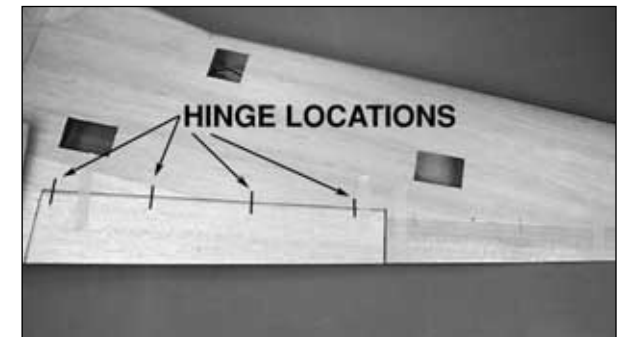

❑ 1. Place the flaps and ailerons over the wing plan in their proper locations and mark the hinge locations. Tape the flaps and ailerons onto the wing and transfer the hinge locations onto the wing.



❑ 2. At each hinge location drill a 3/16" hole (depending on the type of hinges you are using) centered on the TE of the wing and LE of the flap and aileron. Use a sharp hobby knife to make a V-notch in the LE of the flap as shown. This will allow the hinge point pivot to be at the center of the radius of the flap LE.

NOTE: The hinges are not glued in until after the finish has been applied

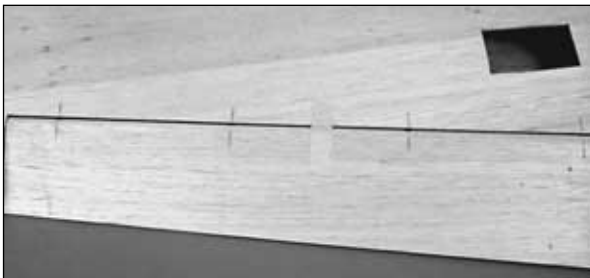

❑ 3. Install the flap on the wing and check its fit and range of motion. Make any required adjustments until the flap moves freely through its range of motion (remember the flap is not required to raise above neutral).

❑ 4. Mark a centerline on the LE of the aileron. Shape the LE of the ailerons to the "V" shape as shown below and on the cross section on the wing plan.



HOW TO BEVEL THE LE

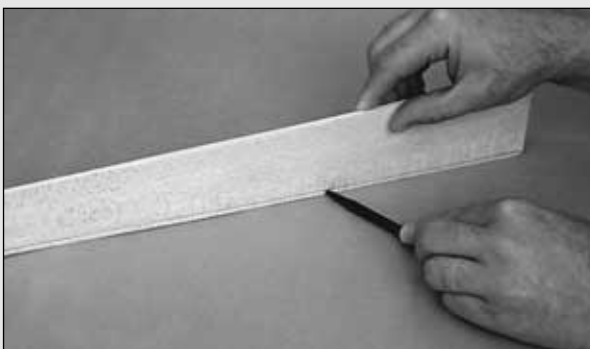

A. Place the LE of one of the ailerons on your work surface and use a pen to mark a "bevel to" line on both sides about 3/16" high.

NOTE: Use a piece of card stock to adjust the height of the pen or aileron as needed.



B. Using the "bevel to" lines and the centerline as a guide, make the "V" on the LE of the aileron with a razor plane or your bar sander.

❑ 5. Use the same method that was used on the aileron to install the elevator and rudder.

INSTALL THE AILERON AND FLAP SERVOS

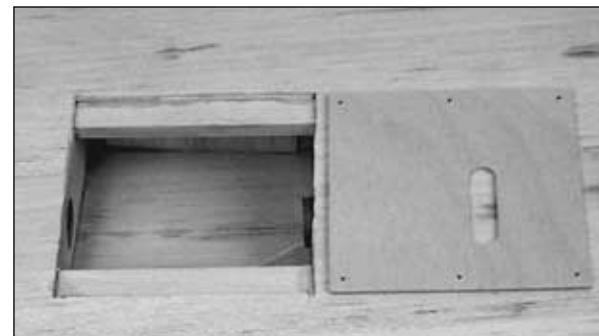

❑ 1. Trace the outline of the die-cut 1/16" plywood aileron and flap servo bay covers accurately onto the wing skin over their proper location. Carefully cut out the bays and fit the covers into place.



❑ 2. Cut **hatch guides** from leftover 1/4" x 1/4" balsa stringers. Use thin CA to glue the guides between the hatch blocks, flush with the bottom of the wing skin.

NOTE: Unless you have a reverse throw servo, you will need to mount the **flap servos** in an asymmetrical manner as shown on the wing plan to have them both move in the same direction.

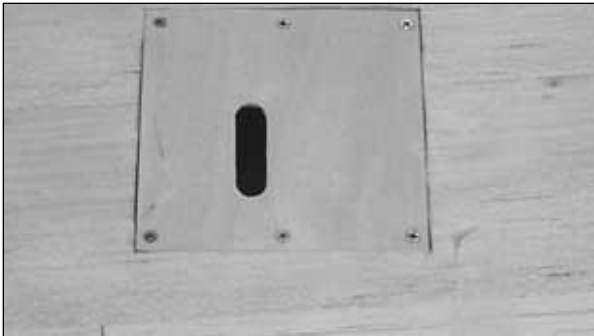

❑ 3. Tape the hatches in place and drill 1/16" pilot holes at the punch marks on the hatches and into the hatch blocks. Remove the hatches and enlarge the holes in them to 3/32". Countersink the holes in the hatches to accept the **#2 x 3/8" flat head screws**. Secure the hatches to the hatch blocks with the #2 x 3/8" flat head screws.

❑ 4. Remove the servo hatches from the wing. Apply a drop of thin CA to each hole in the hatch blocks to harden the threads.

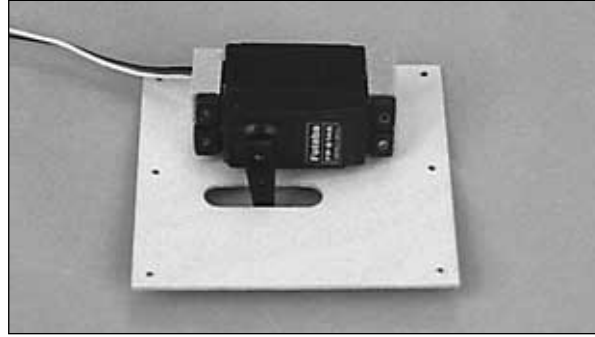

❑ 5. Position the servos on the hatches so that the servo arms are centered in the hatch openings. Use 30-minute epoxy to glue 5/16" x 3/4" x 7/8" basswood **servo mounting blocks** to the servo hatches.

NOTE: Secure the servo mounting blocks by first drilling several 1/16" holes about 3/16" deep into the gluing surface of the basswood blocks. Roughen the servo hatch where the epoxy will be applied. Pack epoxy into the 1/16" holes before clamping the blocks in position.

❑ 6. After the epoxy has fully cured, insert a 1/32" or 1/16" temporary shim between the servo and the plywood hatch. Drill 1/16" pilot holes and mount the servos to the mounting blocks. Remove the shims.

❑ 7. If you are using a four arm "cross" servo horn, trim off three of the four arms. Reinstall the servo hatches in the wing.

❑ 8. Thread a **4-40 nut** onto each of four **4-40 x 12" threaded rods**. Slide a silicone clevis retainer onto each rod followed by a **4-40 threaded metal clevis** threaded on at least 14 turns.

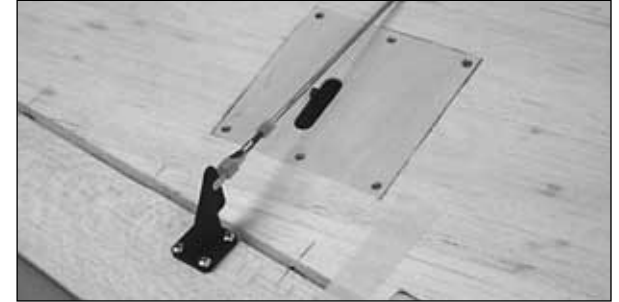

❑ 9. Attach a heavy-duty control horn (not included) to each clevis. With the pushrods aligned with the servo arms, position the control horns on the ailerons and flaps so that the clevis holes are aligned with the LE of the control surfaces. Mark the control horn mounting holes. Depending on the type of control horns used, drill the proper size pilot holes at the marks and mount the control horns to the control surfaces with 1/2" long wood screws (not included). Be careful not to drill through the top skin. Remove the control horns and prick a few holes into the wood under the control horn. Apply several drops of thin CA to the pin holes to strengthen the balsa. After the CA cures, sand smooth and reattach the control horns.



❑ 10. Attach solder clevises to the outermost hole in the servo arms. Center the servo arms, ailerons and flaps. Cut the pushrods to the appropriate length. Remove the pushrods and solder clevises from the wing. Solder the clevises onto one end of each pushrod. Silver solder is highly recommended. Slide a silicone retainer over the solder clevises and reinstall the pushrods on the servo arms and control horns.

INSTALL THE RUDDER PUSHROD

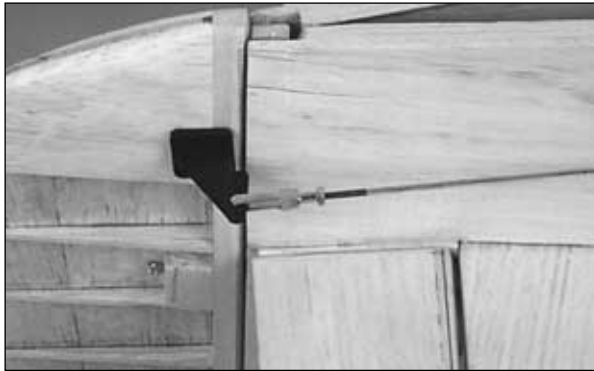

1. Thread a 4-40 nut, a silicone retainer and 4-40 threaded clevis 14 turns onto the end of a 4-40 x 36" threaded pushrod. Attach a heavy-duty control horn (not included) to the clevis and position it on the rudder so that the clevis holes are aligned with the hinge line. Mark the outline of the rudder horn.



2. Center the shaped 1/8" x 1" x 1" plywood **rudder horn base** over the outline of the rudder control horn. Mark the outline of the plywood rudder base. Remove the balsa from inside the outline of the rudder base until it is flush with the side of the rudder.

3. Drill four or five 1/8" diameter holes in the balsa under the rudder base. This will provide more gluing surface to hold the rudder base

securely to the rudder. Use 6-minute epoxy to glue the base to the rudder, making sure to work epoxy into the 1/8" holes.

4. Reinstall the rudder, position the rudder control horn on the rudder base and mark the mounting hole locations. Depending on the type of control horn used, drill the proper size pilot holes at the marks and mount the control horn to the rudder base with wood screws (not included).

5. Center the rudder servo and the rudder. Attach a solder clevis to the outermost hole in the rudder servo arm. Cut the rudder pushrod to the appropriate length. Remove the pushrod and the solder clevis from the fuselage and slide a silicone retainer on the pushrod. Solder the clevis to the pushrod. Reinstall the pushrod and attach the clevises to the servo arm and the control horn.

INSTALL THE THROTTLE PUSHROD

The following throttle pushrod installation is for the U.S. Engines 41cc. The same setup may be used with other brands of engines with only slight modification.

1. Install the throttle servo in position on the servo rails in front of former F-5.

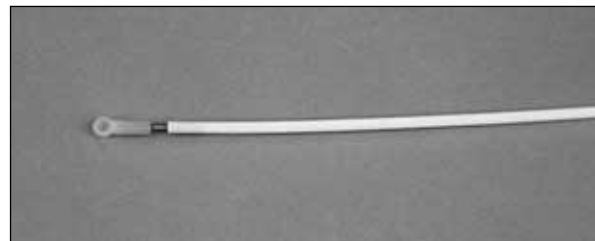

2. Thread the 2-56 x 1" **threaded stud** into the nylon **ball link**. Thread this assembly 1/2" or more into the end of the white nylon 36" **inner pushrod tube**.

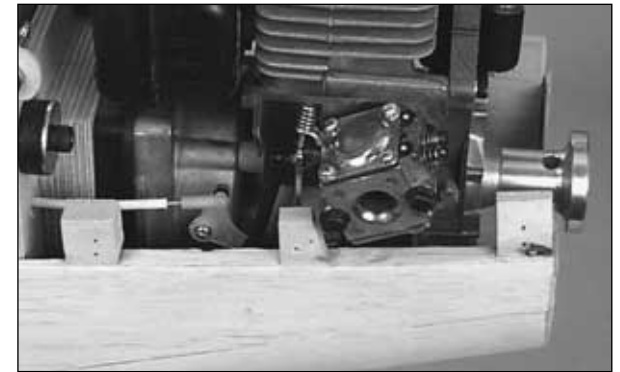

3. Insert the inner pushrod into the throttle outer pushrod tube. Install the pivot ball on the throttle arm and secure it with a nut. Attach the ball link to the pivot ball on the throttle.



4. Attach the **Screw-Lock Pushrod Connector** to the throttle servo arm. Slide a 2-56 x 4" **threaded pushrod** through the pushrod connector and mark the inner pushrod approximately 1/2" forward of the threads. Cut the inner pushrod and thread the 2-56 x 4" threaded pushrod 1/2" into the inner pushrod. Secure the pushrod in the screw-lock pushrod connector with a 4-40 x 1/8" cap screw.

RETRACT INSTALLATION

1. Enlarge the retract opening in the bottom wing skin and mount the retracts on the retract rails.

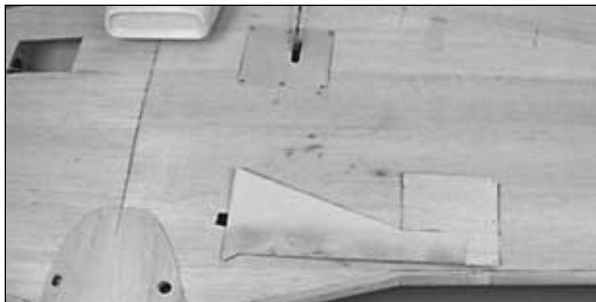

2. Gradually increase the size of the cut-out until the retract operates properly. Position the 1/16" die-cut plywood **retract hatch** and the 1/8" die-cut plywood **main gear door** on the bottom wing skin. Note that the radius at the bottom of the gear door must be sanded off. Trace around the cover and door.

3. Mount the retract cover to the R-4 and R-5 ribs with #2 x 3/8" flat head screws following the same procedure used when mounting the aileron and flap hatches. A piece of leftover plywood will need to be glued to rib R-4 for the forward screw on the retract hatch.



4. You may make wheel well liners from vertical grain 1/16" balsa, 1/64" plywood or a number of other methods – or, you may leave your wheel wells open.

NOTE: Fuelproof the wheel wells. Die-cut 1/8" plywood main gear doors are provided in the kit if you prefer to install them.

5. Install the 1-3/4" tailwheel (not included) on the retractable tail gear (not included). Move the retractable tail gear through its full range of motion to check for any binding or interference.

6. Sand the bottom of the aft fuselage sides flush with formers F-10 and F-11.



7. The **aft fuse bottom** is covered with leftover 1/4" balsa sheet from the radiator corners. We found that using two pieces of balsa, one in front of the retract and one behind it, works best. Use smaller pieces along the sides of the retract. Make sure to leave enough room to remove the retract and for the tailwheel to move through its full range of motion, even if it's turned slightly. Glue the sheeting in place when satisfied with the fit.

8. Use the aft fuse cross sections as a guide for the proper shape of the aft fuse bottom and radiator. The aft fuse bottom should be shaped with the rudder taped in place and the wing installed.



9. Install the retract servo on the servo rails in front of former F-5. The air control valve can be mounted on the fourth die-cut 1/8" plywood valve mount and attached to the front of former F-5.

10. The retract air tank fits in the built-in cradle in formers F-8 and TT and can be secured with double-sided tape or silicone sealant.

FINISHING

SURFACE PREPARATION



1. Make a fillet along the joint between the fin and stab and on the bottom of the stab between the stab and fuse sides as follows: Attach a piece of masking tape on top of the stab approximately 1/4" from the fin. Apply another piece of tape on the fin approximately 1/4" above the stab. Mix an even amount of 30-minute epoxy and milled fiberglass and apply it to the joint between the fin and stab. Cover your hand with a plastic glove and

slightly contour the epoxy to make a fillet. Remove the masking tape, wet your finger with isopropyl alcohol and blend the epoxy mix into the stab, fin and fuse sides.

FINAL SANDING

Remove the engine, servos, control horns and any other hardware that may restrict sanding. All edges should be rough sanded and rounded following the cross-section views on the plan. Nearly every imperfection in your wood structure will show through the covering material; therefore, before covering, you should make a final check of the entire structure. Fix any “dings” before sanding the entire structure. Fill all dents, seams, low spots and notches with HobbyLite™ balsa-colored filler.



Here is an easy method to remove minor dents in wood where the wood grain has not been broken.

- A.** Wet the area of the dent with water.
- B.** Carefully rub a hot sealing iron over the dent.
- C.** As the wet wood is heated, the wood grain will swell up.
- D.** Allow the wood to dry before sanding smooth.

After the filler has dried, use progressively finer grades of sandpaper to even and smooth all the edges, seams and surfaces. Remove all the balsa dust from the model with compressed air or a vacuum with a brush and a tack cloth.

BALANCE THE MODEL Laterally

Do not confuse this procedure with “checking the C.G.” that will be discussed later in the manual.

Now that the model is nearly completed, you should balance it laterally (side-to-side). An airplane that is laterally balanced will track better. Here’s how:

- ❑ 1. Temporarily attach the elevators, rudder, engine, cowl, landing gear and wing. Lift the model by the propeller shaft and the bottom of the fuse near the rudder. This will require an assistant. Do this several times.
- ❑ 2. The wing that consistently drops indicates the heavy side. Balance the model by adding weight to the other wing tip.

COVERING



NOTE: The vacuum formed machine guns may be “sunk into” the wing, flush with the LE, or they may be trimmed and painted separately and glued on after covering.

Cover the model with Top Flite® MonoKote® film, using the suggested covering sequence that follows. Before you cover the fuselage, first apply 3/8" wide strips of MonoKote film in the corners where the stab meets the fuselage and the fin meets the stab. Then, proceed to cover the fin and

stab with pre-cut pieces that meet in the corners and overlap the 1/4" strips. Never cut the covering on the stab and fin after it has been applied except around the leading and trailing edges and the tips. Modelers who do this may cut through the covering and into the stab and fin. This will weaken the structure to a point where it may fail during flight.

Some modelers prefer to cover the top and bottom of the ailerons with one strip of MonoKote film. This is done by covering the bottom first, then wrapping the MonoKote film up over the leading edge.

We used Top Flite MonoKote Aluminum, White, Black, Flat Black and Sky Blue to cover our P-51D.

NOTE: See the **Apply Trim** section for hints on how to apply covering details.

Suggested Covering Sequence

Fuselage and Tail:

1. 3/8" strips at fin and stab as described
2. Aluminum on the wing fillets of the fuse
3. Aluminum on aft fuselage bottom
4. Aluminum on forward fuselage bottom
5. Fuselage right side up to the Sky Blue on the turtle deck and the Black on the nose
6. Fuselage left side up to the Sky Blue on the turtle deck and the Black on the nose
7. White followed by the Black strips on the aft fuselage bottom
8. Sky Blue on the turtle deck
9. Black on the nose
10. Fin TE, followed by stab tip and TE
11. Stab bottom, followed by top
12. Fin right side, followed by the left side
13. Elevator LE and root ends
14. Elevator bottoms, followed by the top
15. Rudder LE, right side followed by the left side

Wing:

1. Tips of wing
2. Trailing edges of wing
3. Aluminum on the bottom right, followed by the left wing panel
4. Aluminum on the top right, followed by the left wing panel
5. White followed by the Black stripes on the bottom right, followed by the left wing panel
6. White followed by the Black stripes on the top right, followed by the left wing panel
7. Aileron tips, followed by the Aluminum on the bottom and top of the ailerons
8. White followed by the Black stripes on the bottom and top of the ailerons

When covering concave surfaces, follow the iron with a damp cloth, pressing the covering down.

APPLY TRIM

The area ahead of the canopy can be covered with Flat Black MonoKote. If gloss Black MonoKote is used, finish covering the model; then, before the canopy is installed, mask and spray this panel with Flat Clear LustreKote.



The nose checkerboard was done with MonoKote, with the exception of the plastic cowling.

The nose checkerboard is not extremely difficult to do. It is, however, tedious and time consuming to apply. Sport modelers who do not want to spend

the necessary time on the checkerboard, but still want to use the supplied decals etc., may consider applying a solid-colored nose such as blue or yellow instead.

The following sequence was used on the prototypes:

The cowling should be primed and painted white before proceeding with the checkerboard. LustreKote™ paints are recommended (see the **Painting** section).

- ❑ 1. Cover the entire nose section of the model in the checkerboard region with White MonoKote.
- ❑ 2. Screw the plastic cowling to the fuse. We recommend you use a #2 pencil when marking on the cowling.
- ❑ 3. Divide the fore and aft distance of the checkerboard region at the top into two equal sections. You may use a fine-tip marker to mark the MonoKote. Isopropyl alcohol will remove any exposed marks when you are done. (Pre-test on a scrap of MonoKote.)
- ❑ 4. Repeat these divisions on the fuselage's left and right sides as well as the bottom cowling.
- ❑ 5. Draw rings around the nose of the plane with the marker (and pencil on the cowling). The rings should be even all the way around. The rings may be drawn by applying strips of plastic fine-line masking tape around the fuselage. Run the pen around the fuse using the tape as a guide.
- ❑ 6. Divide the fuse up radially using the box labels and other photos as a reference. Use a straightedge or tape to draw the radial (lengthwise) lines on the fuse and cowl.
- ❑ 7. Custom cut individual pieces of Sky Blue MonoKote to fit each blue panel of the checkerboard. Iron these down as you cut them.

- ❑ 8. Use isopropyl alcohol to remove any exposed marks.
- ❑ 9. For best results, the white parts of the cowling should be masked and the remainder painted Sky Blue to complete the checkerboard.

EXHAUST STACKS



- ❑ 1. Trim the exhaust stacks as closely to the cut lines as you can.
- ❑ 2. Paint the exhaust stacks. We used aluminum LustreKote on the prototypes.
- ❑ 3. Mark the perimeter of the stacks on the fuse. Use a T-pin to perforate the covering underneath the stacks.
- ❑ 4. Roughen the underside of the plastic stacks with sandpaper.
- ❑ 5. Glue the stacks to the fuse with medium CA.

PAINTING

After the model is covered, use fuelproof model paint, 30-minute epoxy thinned with alcohol or finishing resin to coat areas that may be exposed to raw fuel or exhaust residue such as the firewall, wing saddle and openings in the wing for the retracts.

We recommended Top Flite LustreKote fuelproof paint for painting all ABS plastic parts. At least one coat of LustreKote primer is highly recommended to fill in small scratches left from sanding as well as small pin holes in the filler. Wet sand between coats with 400-grit sandpaper and apply a second coat of primer if necessary.

Before painting the canopy, use a scissors or hobby knife to trim along the molded cut lines. True the edges with your bar sander and 220-grit sandpaper. Use 400-grit sandpaper to scuff the frame portion of the canopy so the paint will stick. We recommend painting the canopy frame with Pactra Formula-U or Chevron Perfect Paint. Use masking tape or frisket film to cover the portion of the canopy that is not to be painted. If you are not sure that the paint is compatible with the clear canopy, test the paint on a leftover piece of canopy material and allow it to dry overnight.

For painting the pilot, we have discovered that acrylic water base paints such as the types found at craft stores work great. The acrylic paints look realistic on the pilots because they are flat. Best of all, they clean up with water.

We covered the cockpit floor (if a cockpit kit will not be installed) sides and backrest with **600-grit** sandpaper glued in place with aliphatic resin glue.

APPLY DECALS

- ❑ 1. Study the plan and the photos on the box to decide where to place the decals.
- ❑ 2. Thoroughly clean your airplane before applying decals.
- ❑ 3. Cut out the individual decals and apply them in the locations shown on the plan.

HINT: To apply decals accurately, use a marker to put small reference marks on the aircraft outside the edge of the decal. Peel the decal backing off. For larger decals, spray the aircraft and the glue side of the decal with a mixture of soap and water. Carefully “float” the decal into position. Use a damp paper towel to squeegee the liquid out from under the decal, working from the middle outward. Remove the marks with isopropyl alcohol.

FINAL HOOKUPS AND CHECKS

INSTALL THE HINGES

- ❑ 1. Starting with the elevators and stab, cut the covering from the hinge holes.
- ❑ 2. Roughen the elevator torque rod wires with sandpaper. Clean the torque rod wires with alcohol and a paper towel to remove any oil residue.
- ❑ 3. Apply petroleum jelly to the hinge joints to prevent epoxy from gluing the hinge joints. Glue the torque rod wires and hinges in the elevators and stab with 30-minute epoxy.
- ❑ 4. Install the ailerons with their hinges. Repeat the gluing technique described previously and allow the epoxy to cure.
- ❑ 5. Install the rudder with its hinges. Repeat the gluing technique described previously and allow the epoxy to cure.

INSTALL THE HARDWARE

- ❑ 1. Reinstall the fuel tank with foam padding (not included) as follows: Insert two 12" pieces of fuel tubing (not included) through the firewall. Connect one of the fuel tubes to the fuel pick-up fitting and the other to the overflow or pressure fitting. Insert the fuel tank into the fuel tank compartment. Connect the fuel tubing from the fuel pick-up fitting to the fuel fill valve. Route the overflow line out the bottom of the cowl.
- ❑ 2. Reinstall the landing gear. Apply thread lock to the engine mounting bolts before mounting the engine to the firewall.
- ❑ 3. Connect the fuel tubing from the fuel fill valve to the carburetor. Connect the pressure line to the muffler if using a glow engine.
- ❑ 4. Reinstall the tail wheel and main wheels.
- ❑ 5. Reinstall the control horns, servos and pushrods. Make sure to slide a silicone retainer over each metal clevis.
- ❑ 6. Plug the servos into the receiver. Wrap the receiver in foam padding and insert it behind the elevator and rudder servos. Secure it in place with a couple of leftover 1/4" square sticks glued to the fuse sides.
- ❑ 7. Install the receiver switch and connect the receiver battery. Wrap the receiver battery in foam. Secure the battery in the fuselage.
- ❑ 8. Switch the radio system on and adjust the servos to neutral. Hook up the pull-pull system for the tail wheel. The tail wheel servo and the rudder servo can be connected using a Y-harness.

ATTACH THE CANOPY

❑ 1. Before permanently installing the **canopy**, securely glue your pilot in place on the cockpit floor, if a full cockpit will not be installed. For the most security, in addition to glue, screw the base of the pilot to the cockpit floor with a #4 sheet metal screw (not included) from the underside of the cockpit floor. If you are installing a full cockpit kit, now is the time to install it. Follow the installation instructions included with the cockpit kit.

❑ 2. Place the canopy on the fuselage in the location shown on the plan. Temporarily hold it in position with tape or rubber bands.

❑ 3. Use a felt-tip pen to accurately trace the canopy outline onto the MonoKote film covering. Remove the canopy.

❑ 4. Without cutting into the balsa, use a sharp hobby knife to carefully cut and remove a strip of covering 1/16" wide, approximately 1/32" inside of the line you made. Wipe away the line with a paper towel dampened with alcohol.

❑ 5. Reposition the canopy on the fuse and confirm that it covers the exposed wood. Glue the canopy to the fuse with a glue formulated for gluing on canopies such as Pacer "Formula 560" canopy glue. Hold the canopy in place with masking tape or rubber bands while the glue dries.

NOTE: For added security, you may want to consider adding some small screws.

SET THE CONTROL THROWS

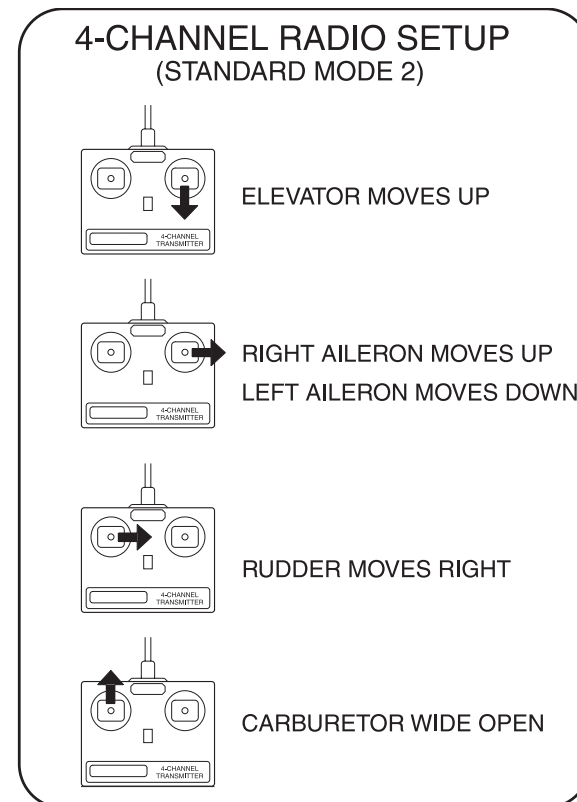

The throws are measured at the widest part of the elevators, rudder, ailerons and flaps. Adjust the position of the pushrods at the servo horns to control the amount of throw. You may also use the ATV's if your transmitter has them. Set the mechanical linkages so the ATV's are near 100% for the best servo resolution (smoothest, most proportional movement).

Note: If your radio does not have dual rates, set the control surfaces to move between the high rate and low rate throws.

We recommend the following control surface throws:

| | High rate | Low rate |
|-----------------------|-----------------------------|----------------------|
| Elevator | 9/16" up 9/16" down | 3/8" up 3/8" down |
| Rudder | 1-1/2" left 1-1/2" right | 1" left 1" right |
| Ailerons | 3/4" up 5/8" down | 1/2" up 3/8" down |
| Flap Positions | 7/8" and 2-1/8" down | |

We added about 20% exponential to the elevator. This reduces the sensitivity of the elevator at the neutral position.

Note: The balance and control throws for the Giant P-51D have been extensively tested. This chart indicates the settings at which the P-51 flies best. Please set up your model to the specifications listed above. If, after you become comfortable with your P-51, you would like to adjust the throws to suit your tastes, that's fine. Too much throw can force the plane into a stall or snap roll, so remember, "more is not always better."

BALANCE YOUR MODEL

NOTE: This section is **VERY** important and must **NOT** be omitted! A model that is not properly balanced will be unstable and possibly unflyable.

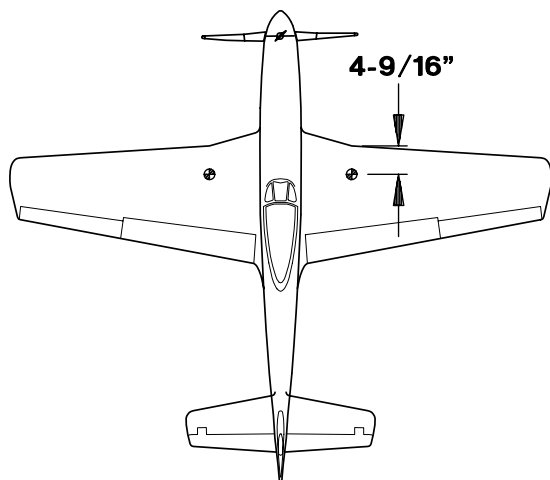

❑ 1. The **balance point (C.G.)** is located **4-9/16"** (116mm) back from the leading edge at the "LE break" as shown in the sketch and on the plan. Accurately mark the balance point on the top of the wing on both sides of the fuselage. Use thin strips of tape or a felt-tip pen to make the marks.

Hint: Reference the fuse plan to help you locate the proper balance point. This is the balance point at which your model should balance for your first flights. After initial trim flights and when you become more acquainted with your P-51, you may wish to experiment by shifting the balance up to **5/16"** forward or backward to change its flying characteristics. Moving the balance forward may improve the smoothness and stability, but the model may then require more speed for takeoff and may become more difficult to slow for landing. Moving the balance aft makes the model more agile with a lighter, snappier "feel" and often

improves knife-edge capabilities. In any case, please start at the location we recommend. Do not at any time balance your model outside the recommended range.



❑ 2. With the wing attached to the fuselage, all parts of the model installed (ready to fly) and an empty fuel tank, hold the model upside down with the stabilizer level. The Great Planes CG Machine™ balancer works great for balancing the model.

❑ 3. Set the model on the balancer at the balance point. If the tail drops, the model is "tail heavy" and you must add weight to the nose to balance the model. If the nose drops, it is "nose heavy" and you must add weight to the tail to balance the model.

If possible, first attempt to balance the model by changing the position of the receiver battery. If you are unable to obtain good balance by doing so, then it will be necessary to add weight to the nose or tail to achieve the proper balance point.

Note: Nose weight may be easily installed by using a "spinner weight" or gluing lead weights to the firewall. Tail weight may be added by using Great Planes (GPMQ4485) "stick-on" lead weights. Later, if the balance is O.K., you can glue the weights inside the tail wheel compartment.

PREFLIGHT

At this time check all connections including servo horn screws, clevises, servo cords and extensions. Make sure you have installed the nylon retainer on the Screw-Lock Pushrod Connector and the silicone retainers on all the clevises.

CHARGE THE BATTERIES

Follow the battery charging procedures in your radio instruction manual. You should always charge your transmitter and receiver batteries the night before you go flying and at other times as recommended by the radio manufacturer.

BALANCE THE PROPELLER

Carefully balance your propellers before flying. An unbalanced prop is the single most significant cause of vibration. Not only may engine mounting screws vibrate out, possibly with disastrous effect, but vibration may also damage your radio receiver and battery. Vibration may cause your fuel to foam, which will, in turn, cause your engine to run lean or quit.

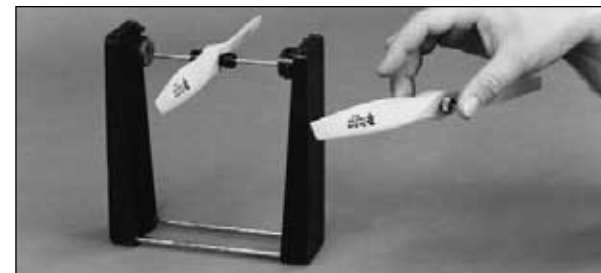

We use a Top Flite Precision Magnetic Prop Balancer (TOPQ5700) in the workshop and keep a Great Planes Fingertip Balancer (GPMQ5000) in our flight box.

FIND A SAFE PLACE TO FLY

Since you have chosen the Giant P-51D, we assume that you are an experienced modeler. Therefore, you should already know about AMA chartered club flying fields and other safe places to fly. If for some reason you are a relatively inexperienced modeler and have not been informed, we strongly suggest that the best place to fly is an AMA chartered club field. Ask the AMA or your local hobby shop dealer if there is a club in your area and join. Club fields are set up for R/C flying and that makes your outing safer and more enjoyable. The AMA address and telephone number is in the front of this manual. If a club and flying site are not available, find a large, grassy area at least 6 miles away from houses, buildings and streets and any other R/C radio operation like R/C boats and R/C cars. A schoolyard may look inviting but is too close to people, power lines and possible radio interference.

GROUND CHECK THE MODEL

Inspect your radio installation and confirm that all the control surfaces respond correctly to the transmitter inputs. The engine operation must also be checked by confirming that the engine idles reliably, transitions smoothly and rapidly to full power and maintains full power, indefinitely. The engine must be “broken-in” on the ground by running it for at least two tanks of fuel. Follow the engine manufacturer’s recommendations for break-in. Make sure all screws remain tight, that the hinges are secure and that the prop is on tight. Cycle and **fully** charge the batteries before going to the flying field.

RANGE CHECK YOUR RADIO

Whenever you go to the flying field, check the operational range of the radio before the first flight of the day. First, make sure no one else is on your

frequency (channel). With your transmitter on, you should be able to walk at least 100 feet away from the model and still have control. While you work the controls, have a helper stand by your model and tell you what the control surfaces are doing. Repeat this test with the engine running at various speeds while a helper holds the model. If the control surfaces are not always responding correctly, do not fly! Find and correct the problem first. Look for loose servo connections or corrosion, loose bolts that may cause vibration, a defective on/off switch, low battery voltage or a defective receiver battery, a damaged receiver antenna, or a receiver crystal that may have been damaged from a previous crash.

ENGINE SAFETY PRECAUTIONS

Note: Failure to follow these safety precautions may result in severe injury to yourself and others.

Keep all engine fuel in a safe place, away from high heat, sparks or flames, as fuel is very flammable. Do not smoke near the engine or fuel; and remember that the engine exhaust gives off a great deal of deadly carbon monoxide. Do not run the engine in a closed room or garage.

Get help from an experienced pilot when learning to operate engines.

Be sure to use safety glasses when starting or running engines.

Do not run the engine in an area of loose gravel or sand; the propeller may throw such material in your face or eyes.

Keep your face and body as well as all spectators away from the plane of rotation of the propeller as you start and run the engine.

Keep these items away from the prop: loose clothing, shirt sleeves, ties, scarfs, long hair or

loose objects such as pencils or screwdrivers that may fall out of shirt or jacket pockets into the prop.

Use a “chicken stick” or electric starter to start the engine. Do not use your fingers to flip the propeller. Make certain the glow plug clip or connector is secure so that it will not pop off or otherwise get into the running propeller.

Make all engine adjustments from behind the rotating propeller.

The engine gets hot! Do not touch it during or right after operation. Make sure fuel lines are in good condition so fuel will not leak onto a hot engine, causing a fire.

To stop a glow engine, cut off the fuel supply by closing off the fuel line or following the engine manufacturer’s recommendations. Do not use hands, fingers or any other body part to try to stop the engine. To stop a gasoline powered engine, a kill switch should be connected to the engine coil. Do not throw anything into the propeller of a running engine.

AMA SAFETY CODE (excerpt)

Read and abide by the following Academy of Model Aeronautics Official Safety Code:

GENERAL

1. I will not fly my model aircraft in sanctioned events, air shows, or model flying demonstrations until it has been proven to be airworthy by having been previously successfully flight tested.

2. I will not fly my model aircraft higher than approximately 400 feet within 3 miles of an airport without notifying the airport operator. I will give right of way to and avoid flying in the proximity of full-scale aircraft. Where necessary, an observer shall be used to supervise flying to avoid having models fly in the proximity of full-scale aircraft.

3. Where established, I will abide by the safety rules for the flying site I use and I will not willfully and deliberately fly my models in a careless, reckless and/or dangerous manner.

7. I will not fly my model unless it is identified with my name and address or AMA number, on or in the model.

9. I will not operate models with pyrotechnics (any device that explodes, burns, or propels a projectile or any kind).

RADIO CONTROL

1. I will have completed a successful radio equipment ground check before the first flight of a new or repaired model.

2. I will not fly my model aircraft in the presence of spectators until I become a qualified flier, unless assisted by an experienced helper.

3. I will perform my initial turn after takeoff away from the pit or spectator areas and I will not thereafter fly over pit or spectator areas, unless beyond my control.

4. I will operate my model using only radio control frequencies currently allowed by the Federal Communications Commission.

IMAA SAFETY CODE (excerpts)

DEFINITION:

For the purpose of the following IMAA Safety Code, the term Giant Scale shall refer to radio controlled model aircraft, either scale or non-scale, which have a wingspan of 80 inches or more for monoplanes and 60 inches or more for multi-winged model aircraft and have a ramp weight (fueled and ready to fly) of 55 lbs. or less.

Section 1.0: SAFETY STANDARD

1.1 Adherence to Code: This safety code is to be strictly followed.

1.2 The most current AMA Safety Code in effect is to be observed. However, the competition sections of the code may be disregarded.

Section 3.0: SAFETY CHECK

3.4 Flight Testing: All Giant Scale R/C aircraft are to have been flight tested and flight trimmed with a minimum of six flights before the model is allowed to fly at an IMAA Sanctioned event.

3.5 Proof of Flight: The completing and signing of the Declaration section of the Safety Inspection form by the pilot (or owner) shall document as fact that each aircraft has been successfully flight-tested and proven airworthy prior to an IMAA event.

Section 5.0: EMERGENCY ENGINE SHUT OFF (kill switch)

5.1 All magneto spark ignition engines must have a coil grounding switch on the aircraft to stop the engine. This will also prevent accidental starting of the engine. This switch shall be readily available to both pilot and helper. This switch is to be operated manually and without the use of the Radio System.

5.2 Engines with battery powered ignition systems must have a switch to turn off the power from the battery pack to disable the engine from firing. This will also prevent accidental starting of the engine. This switch shall be readily available to both pilot and helper. This switch shall be operated manually and without the use of the Radio System.

5.3 There must also be a means to stop the engine from the transmitter. The most common method is to close the carburetor throat completely using throttle trim, however, other methods are acceptable. This requirement applies to all glow/gas ignition engines regardless of size.

Section 6.0: RADIO REQUIREMENTS

6.1 All transmitters must be FCC type certified.

6.2 FCC Technician or higher-class license required for 6 meter band operation only.

Additional General Recommendations

Servos need to be of a rating capable to handle the loads that the control surfaces impose upon the servos. Standard servos are not recommended for control surfaces. Servos should be rated heavy-duty. For flight-critical control functions a minimum of 45 inch/ounces of torque should be considered. This should be considered a minimum for smaller aircraft and higher torque servos are strongly encouraged for larger aircraft. The use of one servo for each aileron and one for each stabilizer half is strongly recommended. Use of dual servos is also recommended for larger aircraft.

On-board batteries shall be 1000 mAh up to 20 lbs., 1200 mAh to 30 lbs., 1800 mAh to 40 lbs. and 2000 mAh over 40 lbs. flying weight. The number and size of servos, size and loads on control surfaces, and added features should be considered as an increase to these minimums. Batteries should be able to sustain power to the onboard radio components for a minimum of one hour total flying time before recharging.

Redundant and fail-safe battery systems are recommended.

The use of anti-glitch devices for long leads are recommended

There is no maximum engine displacement limit, as it is the position of this body that an underpowered aircraft presents a greater danger than an overpowered aircraft. However, the selection of engine size relative to airframe strength and power loading mandates good discretionary judgement by the designer and builder. Current AMA maximums for engine displacement are 6.0 cu. in. for two-stroke and 9.6 cu. in. for four-stroke engines. These maximums apply only to AMA Sanctions concerning competition events (such as 511, 512, 515 and 520) and, as such, the maximums apply. All IMAA (non competition) events should be sanctioned as Class "C" events, in which these engine size maximums do not apply.

Generally, it is recommended that no attempt should be made to fly a radio controlled model aircraft with a gasoline engine in which the model aircraft weight would exceed twelve (12) pounds (underpowered) per cubic inch of engine displacement, or be less than five (5) pounds (overpowered) per cubic inch of engine displacement. Example: Using a 3 cu. in. engine, a model would likely be underpowered at an aircraft weight greater than 36 pounds. With the same engine, an aircraft weighing less than 15 pounds would likely be overpowered.

Servo arms and wheels should be rated heavy duty. Glass filled servo arms and control horns are highly recommended.

Control surfaces linkages are listed in order of preference:

1. Cable system (pull-pull). A tiller bar is highly recommended along with necessary bracing.
2. Arrow Shaft, fiberglass or aluminum, 1/4" or 5/16" O.D. Bracing every six (6) to ten (10) inches is highly recommended.
3. Tube-in-tube (nyrod). Bracing every few inches is highly recommended. Inner tube should be totally enclosed in outer tube.
4. Hardwood dowel, 3/8" O.D. Bracing every six (6) to ten (10) inches is highly recommended.

Hinges should be rated heavy duty and manufactured for Giant Scale use primarily. Home-made and original design hinges are acceptable if determined to be adequate for the intended use.

Clevis (steel, excluding heavy-duty ball links) and attachment hardware should be heavy duty 4-40 threaded rod type. 2-56 threaded size rod is acceptable for some applications (e.g. throttle). Clevis is to have lock nuts and sleeve or spring keepers.

Propeller tips should be painted or colored in a visible and contrasting manner so as to increase the visibility of the propeller tip arc.



THIS MODEL BELONGS TO:

NAME

ADDRESS

CITY STATE ZIP

PHONE #

AMA # / SFA #

Fill in the necessary information, then cut out this placard and place it inside of your model. Don't forget to protect it from fuel and moisture.

FLYING

The Top Flite Giant P-51D is a great-flying scale warbird that flies smoothly and predictably. The P-51 does not, however, possess the self-recovery characteristics of a primary R/C trainer and should be flown only by experienced RC pilots.

Caution (THIS APPLIES TO ALL R/C AIRPLANES): If, while flying, you notice any unusual sounds, such as a low-pitched “buzz”, this may indicate control surface “flutter”. Because flutter can quickly destroy components or your airplane, any time you detect flutter you must immediately cut the throttle and land the airplane! Check all servo grommets for deterioration (this may indicate which surface fluttered) and make sure all pushrod linkages are slop-free. If it fluttered once, it will probably flutter again under similar circumstances unless you can eliminate the slop or flexing in the linkages. Here are some things which can result in flutter: Excessive hinge gap; Not mounting control horns solidly; Sloppy fit of clevis pin in horn; elasticity present in flexible plastic pushrods; Side-play of pushrod in guide tube caused by tight bends; Sloppy fit of control rods in servo horns; Insufficient glue used when gluing in torque rods; Excessive flexing of aileron, caused by using too soft balsa; Excessive “play” or “backlash” in servo gears; and insecure servo mounting.

FUEL MIXTURE ADJUSTMENTS

A fully cowled engine may run at a higher temperature than an un-cowled engine. For this reason, the fuel mixture should be richened so the engine runs at about 200 rpm below peak speed. By running the engine slightly rich, you will help prevent dead stick landings caused by overheating.

TAKEOFF

Takeoff on “high” rates if you have dual rates on your transmitter and with the flaps up - especially if you are taking off into a crosswind. For all models it is good practice to gain as much speed as the length of the runway will permit before lifting off. This will give you a safety margin in case the engine quits. When the plane has gained enough flying speed to safely lift off, gradually and smoothly apply up elevator and allow the model to climb at a shallow angle (do not yank the model off the ground into a steep climb!)

FLIGHT

We recommend that you take it easy with your P-51 for the first several flights, gradually “getting acquainted” with this great model as your engine gets fully broken in. If you feel as though you have your hands full, keep this in mind: pull back on the throttle stick to slow the model down. This will make everything happen a little slower and allow yourself time to think and react. Add and practice one maneuver at a time, learning how the P-51 behaves in each. For smooth flying and normal maneuvers, use the low rate settings as listed on page 53.

Sometimes well before it’s time to land, you should climb your P-51 to a safe altitude, cut the throttle to an idle, lower the flaps completely and check out the model’s low speed characteristics. Do this a few times so you know what to expect upon landing and how the P-51 handles stalls.

LANDING

When it’s time to land, fly a normal landing pattern and approach. Lower the flaps completely, keeping a few clicks of power on until you are over the runway threshold. For your first few landings, plan to land slightly faster than stall speed. Have a ball! But always remember to think about your next move and plan each maneuver before you do it. Impulsively “jamming the sticks” without any thought is what gets most flyers in trouble rather than lack of flying skill. **Happy Landings!**

2-VIEW

Photocopy this page and use the copy to plan your trim scheme.

